



Maintenance and Service Guide

HP Fortis G1i 14 inch Chromebook

SUMMARY

This guide provides maintenance information about such topics as spare parts, removal and replacement of parts, security, and backing up.

Legal information

© Copyright 2025 HP Development Company, L.P.

AMD is a trademark of Advanced Micro Devices, Inc. Bluetooth is a trademark owned by its proprietor and used by HP Inc. under license. Intel is a trademark of Intel Corporation or its subsidiaries in the U.S. and/or other countries. Chrome, ChromeOS, Chromebook, and Google Drive are trademarks of Google LLC. Windows is either registered a trademarks or trademarks of Microsoft Corporation in the United States and/or other countries. Qualcomm and Snapdragon are trademarks of Qualcomm Incorporated, registered in the United States and other countries, used with permission. USB Type-C and USB-C are registered trademarks of USB Implementers Forum. DisplayPort and the DisplayPort logo are trademarks owned by the Video Electronics Standards Association (VESA) in the United States and other countries. Wi-Fi is a registered trademark of Wi-Fi Alliance.

The information contained herein is subject to change without notice. The only warranties for HP products and services are set forth in the express warranty statements accompanying such products and services. Nothing herein should be construed as constituting an additional warranty. HP shall not be liable for technical or editorial errors or omissions contained herein.

First Edition: January 2025

Document Part Number: P27547-001

Product notice

This guide describes features that are common to most models. Some features may not be available on your computer.

Not all features are available in all editions or versions of Windows. Systems may require upgraded and/or separately purchased hardware, drivers, software or BIOS update to take full advantage of Windows functionality. Windows is automatically updated, which is always enabled. High-speed internet and Microsoft account required. ISP fees may apply and additional requirements may apply over time for updates. See <http://www.microsoft.com>.

If your product ships with Windows in S Mode: Windows in S Mode works exclusively with apps from the Microsoft Store within Windows. Certain default settings, features, and apps cannot be changed. Some accessories and apps that are compatible with Windows may not work (including some antivirus, PDF writers, driver utilities, and accessibility apps), and performance may vary, even if you switch out of S Mode. If you switch to Windows, you cannot switch back to S Mode. Learn more at Windows.com/SmodeFAQ.

To access the latest user guides, go to <http://www.hp.com/support>, and follow the instructions to find your product. Then select **Setup & User Guides**.

To help us improve this document, please send any suggestions, comments, or errors to <mailto:hp.doc.feedback@hp.com>. Include the document part number when submitting your feedback.

Software terms

By installing, copying, downloading, or otherwise using any software product preinstalled on this computer, you agree to be bound by the terms of the HP End User License Agreement (EULA). If you do not accept these license terms, your sole remedy is to return the entire unused product (hardware and software) within 14 days for a full refund subject to the refund policy of your seller.

For any further information or to request a full refund of the price of the computer, please contact your seller.

Safety warning notice

Reduce the possibility of heat-related injuries or of overheating the computer by following the practices described.

-
-  **WARNING!** To reduce the possibility of heat-related injuries or of overheating the mobile computer, do not place the mobile computer directly on your lap or obstruct the computer air vents. Use the mobile computer only on a hard, flat surface. Do not allow another hard surface, such as an adjoining optional printer; or a soft surface, such as pillows or rugs or clothing, to block airflow. Also, do not allow the AC adapter to contact the skin or a soft surface, such as pillows or rugs or clothing, during operation. The computer and AC adapter provided by HP comply with the user-accessible surface temperature limits defined by applicable safety standards.
-

Table of contents

1 Product description	1
2 Components	3
Right	3
Left	4
Display	5
Keyboard area	6
Touchpad	6
Speakers	7
Special keys	7
Bottom	8
Labels	9
3 Illustrated parts catalog	11
Chromebook major components	11
Display assembly subcomponents	13
Bracket Kit	14
Miscellaneous parts	15
4 Removal and replacement procedures preliminary requirements	19
Tools required	19
Service considerations	19
Plastic parts	19
Cables and connectors	19
Drive handling	19
Electrostatic discharge information	20
Generating static electricity	20
Preventing electrostatic damage to equipment	21
Personal grounding methods and equipment	21
Grounding the work area	22
Recommended materials and equipment	22
Cleaning your computer	23
Enabling HP Easy Clean (select products only)	23
Removing dirt and debris from your computer	23
Cleaning your computer with a disinfectant	24
Caring for wood veneer (select products only)	25
Packaging and transporting guidelines	25
Accessing support information	25
5 Removal and replacement procedures for Customer Self-Repair parts	28

Component replacement procedures	28
Preparation for disassembly.....	28
Battery.....	28
Removing and reinstalling the same battery	29
Installing a new battery	30
6 Removal and replacement procedures for authorized service provider parts.....	37
Component replacement procedures	37
Preparation for disassembly.....	37
Bottom cover	37
Display subcomponents (without removing the display)	39
Speaker.....	42
WWAN module.....	43
USB board.....	45
WLAN module.....	46
Touchpad	48
Heat sink	50
System board	51
Display assembly.....	53
Lock bracket	60
Top cover with keyboard.....	61
7 Backing up, resetting, and recovering.....	63
Backing up	63
Resetting.....	63
Recovering.....	63
Option 1: Recovering using an internet connection.....	64
Option 2: Installing the Chromebook Recovery Utility.....	64
Creating recovery media	65
Recovering the Chrome operating system with recovery media.....	65
Setting up your computer after a reset or recovery	65
Erasing and reformatting the recovery media	66
8 Statement of memory volatility.....	67
Current BIOS steps	67
Nonvolatile memory usage	69
Questions and answers.....	70
Using HP Sure Start (select products only).....	71
9 Specifications.....	72
Computer specifications.....	72
35.6 cm (14.0 in) display specifications	73
10 Power cord set requirements.....	74
Requirements for all countries	74
Requirements for specific countries and regions.....	74

11 Swelling or deformation of notebook battery	77
Swollen notebook batteries.....	77
Swollen battery is not a safety issue.....	77
Discontinue using a swollen battery.....	77
Replace a swollen battery.....	77
Minimize battery swelling.....	77
HP Adaptive Battery Optimizer (consumer notebooks).....	78
HP Battery Health Manager (commercial notebooks).....	78
12 Recycling	79
Index	80

1 Product description

This table provides detailed product information.

Table 1-1 Product components and their descriptions

Category	Description
Product Name	HP Fortis G11 14 inch Chromebook™
Processors	Intel® N250 (up to 3.8 GHz with Intel Turbo Boost Technology, 6 MB Intel Smart Cache, 4 cores, 6 W) Intel N150 (up to 3.6 GHz with Intel Turbo Boost Technology, 6 MB Intel Smart Cache, 4 cores, 6 W)
Graphics	Internal graphics Intel UHD Graphics
Display panel	14.0 in (35.6 cm), anti glare FHD (1920 × 1080), ultrawide viewing angle (UWVA), 45% NTSC, embedded DisplayPort™ (eDP) 1.2 without panel self-refresh (PSR), 250 nits, touch-on panel (TOP) FHD, UWVA, 45% NTSC, eDP 1.2 without PSR, low power, 300 nits HD (1366 × 768), standard viewing angle (SVA), 45% NTSC, eDP without PSR, 250 nits, touch-on panel (TOP) HD, SVA, 45% NTSC, eDP without PSR, 250 nits
Memory	Supports the following configurations: <ul style="list-style-type: none">• 16 GB, LPDDR5-7500• 8 GB, LPDDR5-7500• 4 GB, LPDDR5-6400
Primary storage	Embedded MultiMedia Controller (eMMC) 5.0 64 GB 32 GB 128 GB
Audio	Dual speakers Waves Maxx Audio
Video	HD camera with dual-array microphone (TNR, narrow field-of-view [NFOV])
Wireless	Wireless Wide Area Network (WWAN) (select products only) Qualcomm® Snapdragon® X12 LTE-Advanced (CAT 6) Wireless Local Area Network (WLAN) Intel AX211 Wi-Fi® 6E + Bluetooth® 5.3 MediaTek MT7921 Wi-Fi 6 + Bluetooth 5.3 <ul style="list-style-type: none">• Supports HP Extended Range WLAN• Supports MU-MIMO

Table 1-1 Product components and their descriptions (continued)

Category	Description
Ports	USB 3.1 Gen 1 Type-C® (2)
	USB 3.1 Gen 1 Type-A (2)
	HDMI 1.4
	Audio-out (headphone)/audio-in (microphone) combo jack
Keyboard/pointing devices	Keyboard with clickpad
	Island style, spill proof
Power requirements	Battery
	47 Whr, 2 cell
	Long life, fast charge
	Smart AC adapter (USB Type-C)
	65 W, straight
	45 W, nPFC, straight
	Power cord
	C5, conventional, power cord with sticker, 1.0 m (3.3 ft), HF
C5, 1.0 m (3.3 ft)	
Security	Titan C security chip
	Nano lock slot
	Camera privacy door
Operating system	Google Chrome™
	Google Chrome with Chrome Education Upgrade
	Google Chrome with Chrome Enterprise Upgrade
Serviceability	End user replaceable parts
	AC adapter

2 Components

Your computer features top-rated components. This chapter provides details about your components, where they are located, and how they work.

Right

Use the illustration and table to identify the components on the right side of the computer.

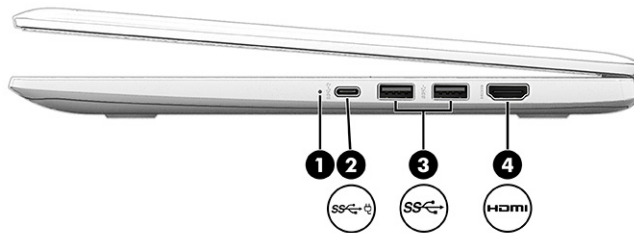

Table 2-1 Right-side components and their descriptions



	Component	Description
(1)	Battery light	<ul style="list-style-type: none"> White: The AC adapter is connected and the battery is fully charged. Amber: The AC adapter is connected and the battery is charging. Off: The AC adapter is not connected.
(2)	 USB Type-C power connector and 5 Gbps port with HP Sleep and Charge and DisplayPort output	Connects an AC adapter that has a USB Type-C connector, supplying power to the computer and, if needed, charging the computer battery. - and - Connects a USB device, provides high-speed data transfer, and charges small devices (such as a smartphone), even when the computer is off. NOTE: Use a standard USB Type-C charging cable or cable adapter (purchased separately) when charging a small external device. - and - Connects a display device that has a USB Type-C connector, providing DisplayPort output.
(3)	 USB 5 Gbps ports (2)	Connect a USB device, provide high-speed data transfer, and (for select products) charge small devices (such as a smartphone) when the computer is on or in sleep mode. NOTE: Use a standard USB Type-A charging cable or cable adapter (purchased separately) when charging a small external device.

Table 2-1 Right-side components and their descriptions (continued)

	Component	Description
(4)	 HDMI port	Connects an optional video or audio device, such as a high-definition television, any compatible digital or audio component, or a high-speed High Definition Multimedia Interface (HDMI) device.

Left

Use the illustration and table to identify the components on the left side of the computer.

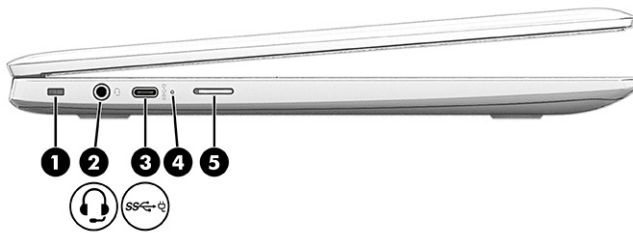

Table 2-2 Left-side components and their descriptions



	Component	Description
(1)	Security cable slot	Attaches an optional security cable to the computer. NOTE: The security cable is designed to act as a deterrent, but it might not prevent the computer from being mishandled or stolen.
(2)	 Audio-out (headphone)/Audio-in (microphone) combo jack	Connects optional powered stereo speakers, headphones, earbuds, a headset, or a television audio cable. Also connects an optional headset microphone. This jack does not support optional standalone microphones. WARNING! To reduce the risk of personal injury, adjust the volume before putting on headphones, earbuds, or a headset. For additional safety information, see the <i>Regulatory, Safety, and Environmental Notices</i> . NOTE: When a device is connected to the jack, the computer speakers are disabled.
(3)	 USB Type-C power connector and 5 Gbps port with HP Sleep and Charge and DisplayPort output	Connects an AC adapter that has a USB Type-C connector, supplying power to the computer and, if needed, charging the computer battery. - and - Connects a USB device, provides high-speed data transfer, and charges small devices (such as a smartphone), even when the computer is off. NOTE: Use a standard USB Type-C charging cable or cable adapter (purchased separately) when charging a small external device. - and - Connects a display device that has a USB Type-C connector, providing DisplayPort output.

Table 2-2 Left-side components and their descriptions (continued)

	Component	Description
(4)	Battery light	<ul style="list-style-type: none"> White: The AC adapter is connected and the battery is fully charged. Amber: The AC adapter is connected and the battery is charging. Off: The AC adapter is not connected.
(5)	SIM card tray	

Display

Use the illustration and table to identify the components on the display.

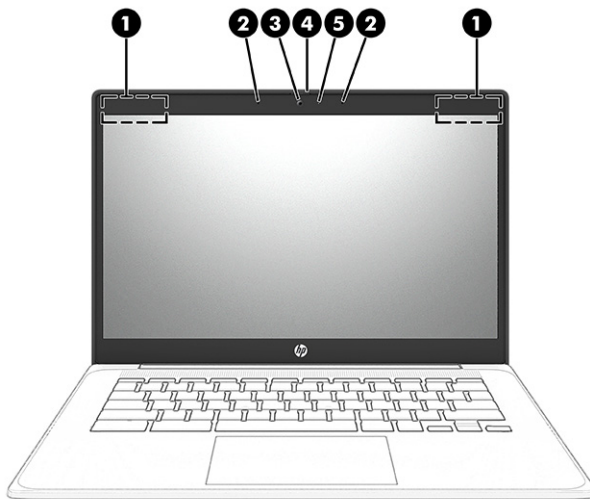

Table 2-3 Display components and their descriptions

	Component	Description
(1)	WLAN antennas* (2) - or - WWAN antennas* (2) (select products only)	Send and receive wireless signals to communicate with wireless local area networks (WLANs). - or - Send and receive wireless signals to communicate with wireless wide area networks (WWANs).
(2)	Internal microphones	Record sound.
(3)	Camera	Allows you to video chat, record video, and record still images. NOTE: Camera functions vary depending on the camera hardware and software installed on your product.

Table 2-3 Display components and their descriptions (continued)

	Component	Description
(4)	Camera privacy cover	By default, the camera lens is uncovered, but you can slide the camera privacy cover to block the camera's view. To use the camera, slide the camera privacy cover in the opposite direction to reveal the lens. NOTE: If you have both front-facing and rear-facing cameras, when one camera lens is revealed and ready to use, the other is concealed.
(5)	Camera light	On (white): The camera is in use. On (amber): The switch turns off the camera. Off: The software has turned off the camera.

*The antennas are not visible from the outside of the computer. For optimal transmission, keep the areas immediately around the antennas free from obstructions.

For wireless regulatory notices, see the section of the *Regulatory, Safety, and Environmental Notices* that applies to your country or region.

Keyboard area

Keyboards can vary by language.

Touchpad

The touchpad settings and components are described here.

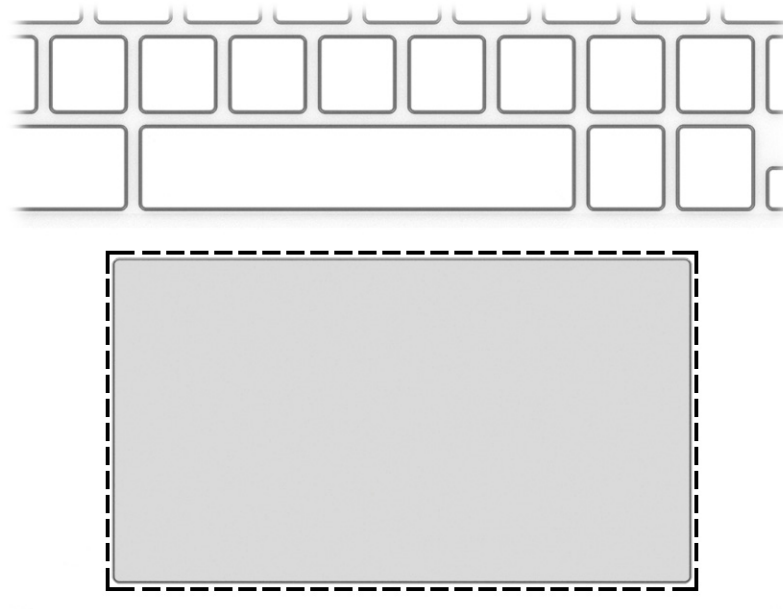

Table 2-4 Touchpad component and description

Component	Description
Touchpad zone	Reads your finger gestures to move the pointer or activate items on the screen.

Speakers

Speakers are located above the keyboard.

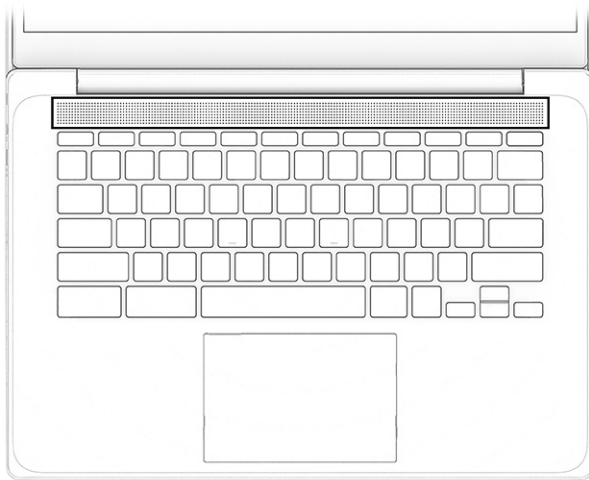

Table 2-5 Speakers and their descriptions

Component	Description
Speakers (2)	Produce sound.

Special keys

Use the illustration and table to locate the special keys.

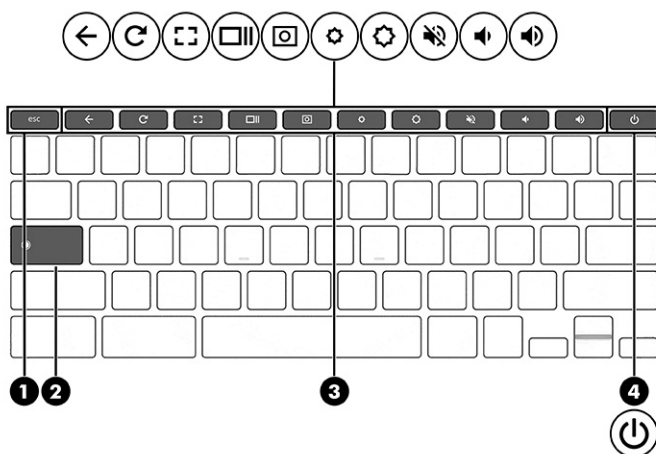



Table 2-6 Special keys and their descriptions

	Component	Description
(1)	esc key	Activates certain computer functions when pressed in combination with other keys, such as tab or shift .
(2)	Search key	Opens the search dialog.
(3)	Action keys	Execute frequently used system functions.
(4)	 Power key	<ul style="list-style-type: none">• When the computer is off, press the key briefly to turn on the computer.• When the computer is on, press the key briefly to initiate Sleep.• When the computer is in the Sleep state, press the key briefly to exit Sleep (select products only). <p>IMPORTANT: Pressing and holding down the power key results in the loss of unsaved information.</p> <p>If the computer has stopped responding and shutdown procedures are ineffective, press and hold the power key for at least 10 seconds to turn off the computer.</p>

Bottom

Use the illustration and table to identify the bottom components.

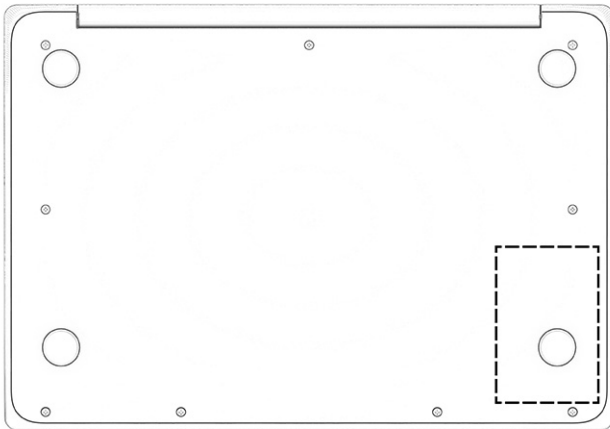

Table 2-7 Bottom component and description

Component	Description
WWAN antennas* (2) (select products only)	Send and receive wireless signals to communicate with wireless local area networks (WLANs).

*The antennas are not visible from the outside of the computer. For optimal transmission, keep the areas immediately around the antennas free from obstructions.

For wireless regulatory notices, see the section of the *Regulatory, Safety, and Environmental Notices* that applies to your country or region.

Labels

The labels affixed to the computer provide information you might need when you troubleshoot system problems or travel internationally with the computer. Labels might be in paper form or imprinted on the product.

 **IMPORTANT:** Check the following locations for the labels described in this section: the bottom of the computer, inside the battery bay, under the service door, on the back of the display, or on the bottom of a tablet kickstand.

- Service label—Provides important information to identify your computer. When contacting support, you might be asked for the serial number, the product number, or the model number. Locate this information before you contact support.

Your service label will resemble one of the following examples. Refer to the illustration that most closely matches the service label on your computer.

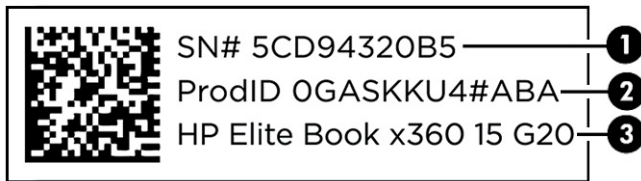

Table 2-8 Service label components

Component	
(1)	Serial number
(2)	Product ID
(3)	HP product name

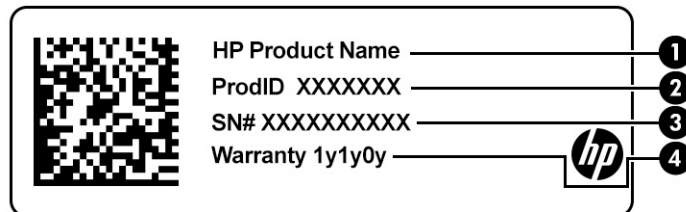

Table 2-9 Service label components

Component	
(1)	HP product name
(2)	Product ID

Table 2-9 Service label components (continued)

Component	
(3)	Serial number
(4)	Warranty period

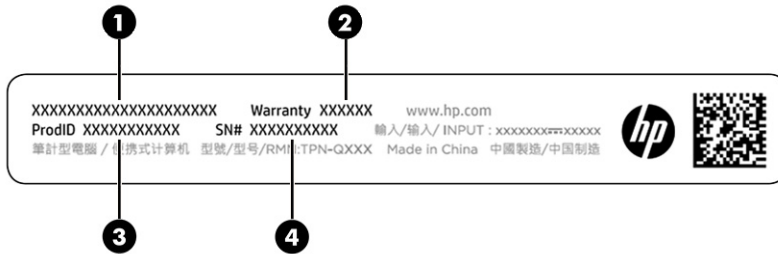

Table 2-10 Service label components

Component	
(1)	HP product name
(2)	Warranty period
(3)	Product ID
(4)	Serial number

- Regulatory labels—Provide regulatory information about the computer.
- Wireless certification labels—Provide information about optional wireless devices and the approval markings for the countries or regions where the devices have been approved for use.

3 Illustrated parts catalog

Use this chapter to determine the spare parts that are available for the computer.

Chromebook major components

To identify the Chromebook™ major components, use this illustration and table.

 **NOTE:** HP continually improves and changes product parts. For complete and current information about supported parts for your computer, go to <http://partsurfer.hp.com>, select your country or region, and then follow the on-screen instructions.

 **NOTE:** Details about your computer, including model, serial number, product key, and length of warranty, are on the service tag at the bottom of your computer.

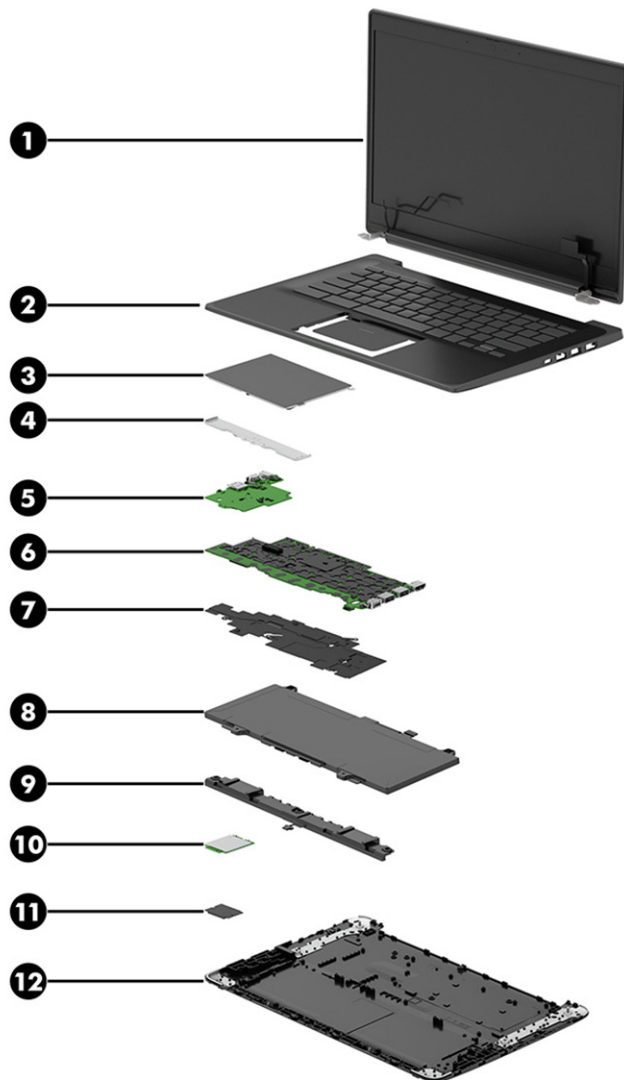

Table 3-1 Chromebox major component descriptions and part numbers

Item	Component	Spare part number
(1)	Display assembly NOTE: Display assemblies are offered as spare parts only at a subcomponent level. For more information, see Display assembly subcomponents on page 13 .	
(2)	Top cover with keyboard For a detailed list of country codes, see Top cover with keyboard on page 61 .	
	Models with WWAN	N83273-001
	Models without WWAN	N83274-001
(3)	Touchpad	N84551-001
(4)	Touchpad bracket NOTE: The touchpad bracket is available in the Bracket Kit as spare part number N84559-001 for models without WWAN or N87094-001 for models with WWAN.	
(5)	USB board	
	Models with WWAN	N84546-001
	Models without WWAN	N84547-001
(6)	System board (includes processor, replacement thermal material, and the Chrome operating system)	
	Intel N200 processor, 16 GB system memory, 128 GB UFS memory	N83261-001
	Intel N200 processor, 16 GB system memory, 128 GB UFS memory (WWAN models)	N83262-001
	Intel N200 processor, 8 GB system memory, 64 GB eMMC memory	N83263-001
	Intel N100 processor, 16 GB system memory, 128 GB UFS memory	N83256-001
	Intel N100 processor, 8 GB system memory, 64 GB eMMC memory	N83259-001
	Intel N100 processor, 8 GB system memory, 64 GB eMMC memory (WWAN models)	N83260-001
	Intel N100 processor, 4 GB system memory, 32 GB eMMC memory	N83257-001
	Intel N100 processor, 4 GB system memory, 32 GB eMMC memory (WWAN models)	N83258-001
(7)	Heat sink (includes replacement thermal material) NOTE: The heat sink thermal pad is available as spare part number M76797-001.	N87095-001
(8)	Battery	M25914-005
(9)	Speaker	N84548-001
(10)	WWAN module (Qualcomm Snapdragon X12 LTE-Advanced [CAT 6])	N42576-005
(11)	WLAN module	
	Intel AX211 Wi-Fi 6E Bluetooth 5.3 WLAN	M53366-005
	MediaTek MT7921 Wi-Fi 6 + Bluetooth 5.3	M74879-005
(12)	Bottom cover	
	Models with WWAN	N90972-001
	Models without WWAN	N90971-001

Display assembly subcomponents

To identify the display assembly subcomponents, use this illustration and table.

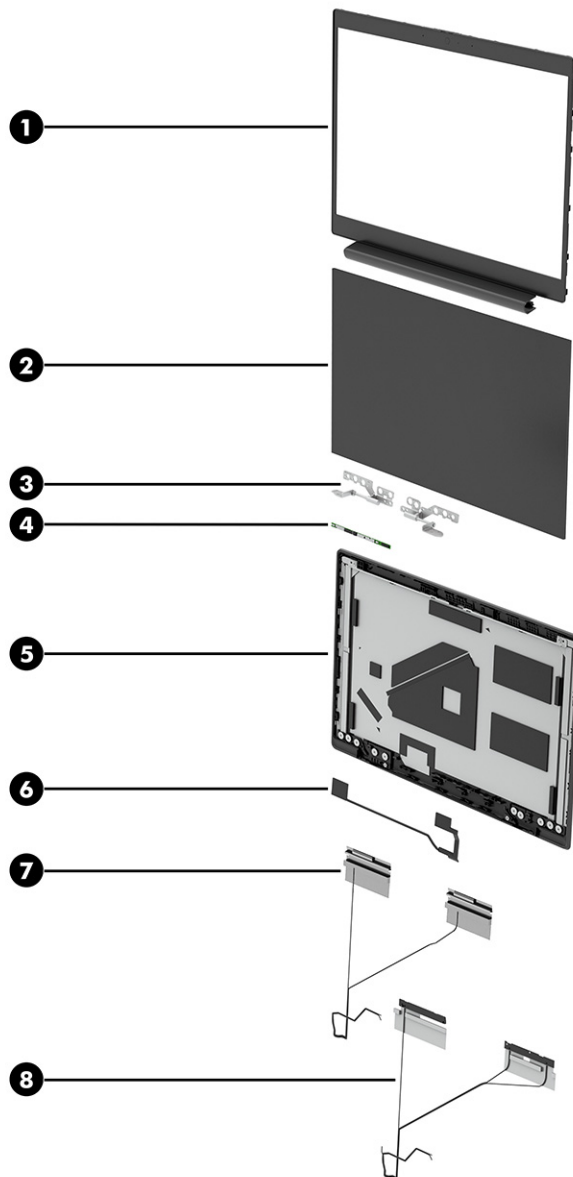

Table 3-2 Display component descriptions and part numbers

Item	Component	Spare part number
(1)	Display bezel	N84553-001
(2)	Display panel	
	FHD, 250 nits	N83269-001
	FHD, 250 nits, touch panel	N83266-001
	FHD, 300 nits, WWAN	N83264-001
	HD, 250 nits	N83268-001

Table 3-2 Display component descriptions and part numbers (continued)

Item	Component	Spare part number
	HD, 250 nits, touch panel	N83271-001
(3)	Hinges (includes left and right display hinges)	N84550-001
(4)	Camera module	N84552-001
(5)	Display back cover (includes wireless antennas)	
	WLAN-only models	N84562-001
	WLAN-only models with a low-power panel	N84563-001
	WWAN-only models	N84564-001
	WWAN-only models with a low-power panel	N84565-001
(6)	Display cable	
	Touch screen, WLAN only	N87096-001
	Non-touch screen, WLAN only	N87097-001
	Touch screen, WWAN + WLAN only	N93426-001
	Non-touch screen, WWAN + WLAN only	N93427-001
(7)	WLAN antennas and cables (includes bezel adhesive)	N84554-001
(8)	WWAN antennas and cables (includes bezel adhesive)	N84555-001
*	WLAN Cable Kit (includes USB cable and touchpad cable)	N84557-001
*	WWAN FPC cable	N87099-001
*	WWAN Cable Kit (includes USB cable, touchpad cable, and memory absorber)	N87098-001
	*not illustrated	

Bracket Kit

To identify the bracket kit components, use this illustration and table.

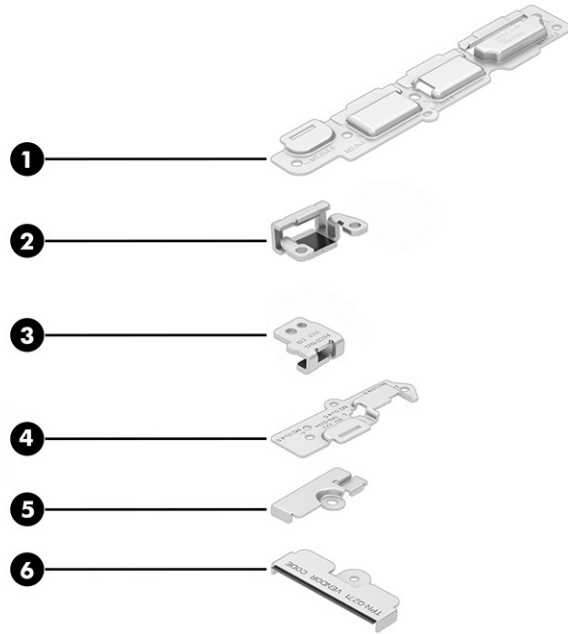

Table 3-3 Bracket kit descriptions and part numbers

Item	Component	Spare part number
	Bracket Kit (models without WWAN)	N84559-001
	Bracket Kit (models with WWAN)	N87094-001
(1)	System board USB bracket (large)	
(2)	USB bracket (USB board [small] and system board)	
(3)	Lock bracket	
(4)	Connector board bracket	
(5)	WLAN module antenna protector	
(6)	WWAN module antenna protector (WWAN models only)	
*	Display panel bracket	
*	Touchpad bracket	
*	SIM tray (WWAN models only)	
	*not illustrated	

Miscellaneous parts

To identify the miscellaneous parts, use this table.

Table 3-4 Miscellaneous part descriptions and part numbers

Component	Spare part number
AC adapter (USB Type-C)	

Table 3-4 Miscellaneous part descriptions and part numbers (continued)

Component	Spare part number
65 W AC adapter (non-PFC)	M54350-001
45 W (non-PFC 1.8 m [6 ft], wall mount)	L32390-001
45 W (non-PFC 1.8 m [6 ft])	L43407-001
Adapters	
HDMI-to-VGA	701943-001
USB-C-to-VGA	831751-001
USB-C [®] -to-USB-A	916838-001
USB-C-to-HDMI 2.0	935325-001
USB-C-to-DisplayPort™	831753-001
USB 3.0-to-gigabit RJ-45	M95984-001
USB-C-to-RJ-45	M95985-001
USB-C-to-RJ-45 (TAA)	N22602-001
HDMI-to-VGA (TAA)	N25154-001
USB-C-to-DisplayPort (TAA)	N25155-001
HP Sure Key Cable Lock	L65088-001
HP Universal Multiport Hub, USB-C	M96882-001
HP Universal Multiport Travel Hub, USB-C	N60372-001
HP USB-C Travel Hub	L72056-001
HP 14.1 Business Slim Top Load Case	L05333-001
HP Prelude Pro 15.6 Backpack	M03617-001
HP Prelude Pro 15.6 Top Load Case	M03618-001
HP Business 14.1 Laptop Bag	M55007-001
HP Renew 14.1 Laptop Sleeve	N19981-001
HP Nano Lock	918431-001
Screw Kit	N84556-001
Misc Parts Kit (includes memory absorber, top shield protective cover, and rubber with protective Mylar)	N84558-001
Duckhead power connector (for use in Japan)	
Japan	L33157-001
South Korea	L50818-001
North America	L50818-002
Power cord (C5, 1.0 m [3.3 ft], conventional with sticker)	
Argentina	L19357-001
Australia	L19358-001
Brazil	L19359-001

Table 3-4 Miscellaneous part descriptions and part numbers (continued)

Component	Spare part number
Denmark	L19360-001
Denmark (HF)	M79264-001
Europe (Austria, Belgium, Finland, France, Germany, the Netherlands, Norway, and Sweden)	L19361-001
Europe (HF)	M79266-001
India	L19363-002
Israel	L19362-001
Israel (HF)	M82712-001
Italy	L19364-001
Japan	L19365-001
North America	L19367-001
People's Republic of China	L19368-001
South Africa	L19369-001
South Korea	L19366-001
Switzerland	L19370-001
Switzerland (HF)	M79265-001
Taiwan	L19372-001
Thailand	L19371-001
United Kingdom	L19373-001
United Kingdom (HF)	M82711-001
Power cord (C5, premium, straight, 1.0 m [3.3 ft])	
Argentina	L30811-001
Australia	L22327-001
Brazil	L30812-001
Denmark	L22322-001
Europe (Austria, Belgium, Finland, France, Germany, the Netherlands, Norway, and Sweden)	L22321-001
India	L22624-001
Italy	L30813-001
Israel	L22323-001
Japan	L22330-001
North America	L22319-001
People's Republic of China	L21930-001
South Africa	L22325-001
South Korea	L22328-001
Switzerland	L22324-001

Table 3-4 Miscellaneous part descriptions and part numbers (continued)

Component	Spare part number
Taiwan	L22329-001
Thailand	L22326-001
Thailand + ADP bundle	M85421-001
United Kingdom	L22320-001
Power cord (C5, FDH, premium, straight, 1.0 m [3.3 ft])	
Argentina	L36815-001
Australia	L36816-001
Brazil	L44789-001
Europe (Austria, Belgium, Finland, France, Germany, the Netherlands, Norway, and Sweden)	L36818-001
India	L36820-001
Italy	L44788-001
Israel	L36819-001
North America	L36822-001
People's Republic of China	L36823-001
South Africa	L36824-001
Switzerland	L36825-001
Taiwan	L36827-001
United Kingdom	L36828-001

4 Removal and replacement procedures preliminary requirements

Use this information to properly prepare to disassemble and reassemble the computer.

Tools required

You need the following tools to complete the removal and replacement procedures:

- Tweezers
- Nonconductive, nonmarking pry tool
- Magnetic Phillips P1 screwdriver

Service considerations

The following sections include some of the considerations that you must keep in mind during disassembly and assembly procedures.

 **NOTE:** As you remove each subassembly from the computer, place the subassembly and all accompanying screws away from the work area to prevent damage.

Plastic parts

Using excessive force during disassembly and reassembly can damage plastic parts.

Cables and connectors

Handle cables with extreme care to avoid damage.

 **IMPORTANT:** When servicing the computer, be sure that cables are placed in their proper locations during the reassembly process. Improper cable placement can damage the computer.

Apply only the tension required to unseat or seat the cables during removal and insertion. Handle cables by the connector whenever possible. In all cases, avoid bending, twisting, or tearing cables. Be sure that cables are routed so that they cannot be caught or snagged as you remove or replace parts. Handle flex cables with extreme care; these cables tear easily.

Drive handling

Note the following guidelines when handling drives.

 **IMPORTANT:** Drives are fragile components. Handle them with care. To prevent damage to the computer, damage to a drive, or loss of information, observe these precautions:

- Before removing or inserting a hard drive, shut down the computer. If you are unsure whether the computer is off or in Hibernation or Sleep mode, turn the computer on, and then shut it down through the operating system.

- Before handling a drive, be sure that you are discharged of static electricity. While handling a drive, avoid touching the connector.
 - Before removing an optical drive, be sure that a disc is not in the drive, and be sure that the optical drive tray is closed.
 - Handle drives on surfaces covered with at least 2.54 cm (1 inch) of shock-proof foam.
 - Avoid dropping drives from any height onto any surface.
 - After removing a hard drive or an optical drive, place it in a static-proof bag.
 - Avoid exposing an internal hard drive to products that have magnetic fields, such as monitors or speakers.
 - Avoid exposing a drive to temperature extremes or liquids.
 - If a drive must be mailed, place the drive in a bubble pack mailer or other suitable form of protective packaging, and label the package "FRAGILE."
-

Electrostatic discharge information

A sudden discharge of static electricity from your finger or other conductor can destroy static-sensitive devices or microcircuitry. Often the spark is neither felt nor heard, but damage occurs. An electronic device exposed to electrostatic discharge (ESD) might not appear to be affected at all and can work perfectly throughout a normal cycle. The device might function normally for a while, but it has been degraded in the internal layers, reducing its life expectancy.

Networks built into many integrated circuits provide some protection, but in many cases, the discharge contains enough power to alter device parameters or melt silicon junctions.

 **IMPORTANT:** To prevent damage to the device when you remove or install internal components, observe these precautions:

- Keep components in their electrostatic-safe containers until you are ready to install them.
 - Before touching an electronic component, discharge static electricity by using the guidelines described in [Personal grounding methods and equipment on page 21](#).
 - Avoid touching pins, leads, and circuitry. Handle electronic components as little as possible.
 - If you remove a component, place it in an electrostatic-safe container.
-

Generating static electricity

Follow these static electricity guidelines:

- Different activities generate different amounts of static electricity.
- Static electricity increases as humidity decreases.

Table 4-1 Static electricity occurrence based on activity and humidity

Event	55% relative humidity	40% relative humidity	10% relative humidity
Walking across carpet	7,500 V	15,000 V	35,000 V
Walking across vinyl floor	3,000 V	5,000 V	12,000 V
Motions of bench worker	400 V	800 V	6,000 V
Removing dual in-line packages (DIPs) from plastic tube	400 V	700 V	2,000 V
Removing DIPs from vinyl tray	2,000 V	4,000 V	11,500 V
Removing DIPs from polystyrene foam	3,500 V	5,000 V	14,500 V
Removing bubble pack from PCB (printed circuit board)	7,000 V	20,000 V	26,500 V
Packing PCBs in foam-lined box	5,000 V	11,000 V	21,000 V

 **NOTE:** Multiple electric components can be packaged together in plastic tubes, trays, or polystyrene foam.

As little as 700 V of static electricity can degrade a product.

Preventing electrostatic damage to equipment

Many electronic components are sensitive to ESD. Circuitry design and structure determine the degree of sensitivity.

The following packaging and grounding precautions are necessary to prevent static electricity damage to electronic components:

- To avoid hand contact, transport products in static-safe containers such as tubes, bags, or boxes.
- Protect all electrostatic parts and assemblies with conductive or approved containers or packaging.
- Keep electrostatic-sensitive parts in their containers until they arrive at static-free stations.
- Place items on a grounded surface before removing them from their container.
- Always be properly grounded when touching a sensitive component or assembly.
- Avoid contact with pins, leads, or circuitry.
- Place reusable electrostatic-sensitive parts from assemblies in protective packaging or conductive foam.

Personal grounding methods and equipment

Using certain equipment can prevent static electricity damage to electronic components.

- **Wrist straps** are flexible straps with a maximum of $1\text{ M}\Omega \pm 10\%$ resistance in the ground cords. To provide proper ground, wear a strap snug against bare skin. Verify that the ground cord is connected and fits snugly into the banana plug connector on the grounding mat or workstation.
- You can use **heel straps, toe straps, and boot straps** at standing workstations. These straps are compatible with most types of shoes or boots. On conductive floors or dissipative floor mats, use them on both feet with a maximum of $1\text{ M}\Omega \pm 10\%$ resistance between the operator and ground.

Table 4-2 Static shielding protection levels

Method	Voltage
Antistatic plastic	1,500
Carbon-loaded plastic	7,500
Metallized laminate	15,000

Grounding the work area

To prevent static damage at the work area, follow these precautions:

- Cover the work surface with approved static-dissipative material.
- Use a wrist strap connected to a properly grounded work surface and use properly grounded tools and equipment.
- Use static-dissipative mats, foot straps, or air ionizers to give added protection.
- Handle electrostatic sensitive components, parts, and assemblies by the case or PCB laminate. Handle them only at static-free work areas.
- Turn off power and input signals before inserting and removing connectors or test equipment.
- Use fixtures made of static-safe materials when fixtures must directly contact dissipative surfaces.
- Keep the work area free of nonconductive materials, such as ordinary plastic assembly aids and polystyrene foam.
- Use conductive field service tools, such as cutters, screwdrivers, and vacuums.
- Avoid contact with pins, leads, or circuitry.

Recommended materials and equipment

HP recommends certain materials and equipment to prevent static electricity:

- Antistatic tape
- Antistatic smocks, aprons, or sleeve protectors
- Conductive bins and other assembly or soldering aids
- Conductive foam
- Conductive tabletop workstations with ground cord of $1\text{ M}\Omega \pm 10\%$ resistance
- Static-dissipative table or floor mats with hard tie to ground
- Field service kits
- Static awareness labels
- Wrist straps and footwear straps providing $1\text{ M}\Omega \pm 10\%$ resistance
- Material handling packages
- Conductive plastic bags

- Conductive plastic tubes
- Conductive tote boxes
- Opaque shielding bags
- Transparent metallized shielding bags
- Transparent shielding tubes

Cleaning your computer

Cleaning your computer regularly removes dirt and debris so that your device continues to operate at its best. Use the following information to safely clean the external surfaces of your computer.

Enabling HP Easy Clean (select products only)

HP Easy Clean helps you to avoid accidental input while you clean the computer surfaces. This software disables devices such as the keyboard, touch screen, and touchpad for a preset amount of time so that you can clean all computer surfaces.

1. Start HP Easy Clean in one of the following ways:
 - Select the **Start** menu, and then select **HP Easy Clean**.
 - Select the **HP Easy Clean** icon in the taskbar.
 - Select **Start**, and then select the **HP Easy Clean** tile.
2. Now that your device is disabled for a short period, see [Removing dirt and debris from your computer on page 23](#) for the recommended steps to clean the high-touch, external surfaces on your computer. After you remove the dirt and debris, you can also clean the surfaces with a disinfectant. See [Cleaning your computer with a disinfectant on page 24](#) for guidelines to help prevent the spread of harmful bacteria and viruses.

Removing dirt and debris from your computer

Here are the recommended steps to clean dirt and debris from your computer.

For computers with wood veneer, see [Caring for wood veneer \(select products only\) on page 25](#).

1. Wear disposable gloves made of latex (or nitrile gloves, if you are latex-sensitive) when cleaning the surfaces.
2. Turn off your device and unplug the power cord and other connected external devices. Remove any installed batteries from items such as wireless keyboards.

 **CAUTION:** To prevent electric shock or damage to components, never clean a product while it is turned on or plugged in.

3. Moisten a microfiber cloth with water. The cloth should be moist, but not dripping wet.

 **IMPORTANT:** To avoid damaging the surface, avoid abrasive cloths, towels, and paper towels.

4. Wipe the exterior of the product gently with the moistened cloth.

 **IMPORTANT:** Keep liquids away from the product. Avoid getting moisture in any openings. If liquid makes its way inside your HP product, it can cause damage to the product. Do not spray liquids directly on the product. Do not use aerosol sprays, solvents, abrasives, or cleaners containing hydrogen peroxide or bleach that might damage the finish.

5. Start with the display (if applicable). Wipe carefully in one direction, and move from the top of the display to the bottom. Finish with any flexible cables, like power cord, keyboard cable, and USB cables.
6. Be sure that surfaces have completely air-dried before turning the device on after cleaning.
7. Discard the gloves after each cleaning. Clean your hands immediately after you remove the gloves.

See [Cleaning your computer with a disinfectant on page 24](#) for recommended steps to clean the high-touch, external surfaces on your computer to help prevent the spread of harmful bacteria and viruses.

Cleaning your computer with a disinfectant

The World Health Organization (WHO) recommends cleaning surfaces, followed by disinfection, as a best practice for preventing the spread of viral respiratory illnesses and harmful bacteria.

After cleaning the external surfaces of your computer using the steps in [Removing dirt and debris from your computer on page 23](#), [Caring for wood veneer \(select products only\) on page 25](#), or both, you might also choose to clean the surfaces with a disinfectant. A disinfectant that is within HP's cleaning guidelines is an alcohol solution consisting of 70% isopropyl alcohol and 30% water. This solution is also known as rubbing alcohol and is sold in most stores.

Follow these steps when disinfecting high-touch, external surfaces on your computer:

1. Wear disposable gloves made of latex (or nitrile gloves, if you are latex-sensitive) when cleaning the surfaces.
2. Turn off your device and unplug the power cord and other connected external devices. Remove any installed batteries from items such as wireless keyboards.

 **CAUTION:** To prevent electric shock or damage to components, never clean a product while it is turned on or plugged in.

3. Moisten a microfiber cloth with a mixture of 70% isopropyl alcohol and 30% water. The cloth should be moist, but not dripping wet.

 **CAUTION:** Do not use any of the following chemicals or any solutions that contain them, including spray-based surface cleaners: bleach, peroxides (including hydrogen peroxide), acetone, ammonia, ethyl alcohol, methylene chloride, or any petroleum-based materials, such as gasoline, paint thinner, benzene, or toluene.

 **IMPORTANT:** To avoid damaging the surface, avoid abrasive cloths, towels, and paper towels.

4. Wipe the exterior of the product gently with the moistened cloth.

 **IMPORTANT:** Keep liquids away from the product. Avoid getting moisture in any openings. If liquid makes its way inside your HP product, it can cause damage to the product. Do not spray liquids directly on the product. Do not use aerosol sprays, solvents, abrasives, or cleaners containing hydrogen peroxide or bleach that might damage the finish.

5. Start with the display (if applicable). Wipe carefully in one direction, and move from the top of the display to the bottom. Finish with any flexible cables, like power cord, keyboard cable, and USB cables.
6. Be sure that surfaces have completely air-dried before turning the device on after cleaning.
7. Discard the gloves after each cleaning. Clean your hands immediately after you remove the gloves.

Caring for wood veneer (select products only)

Your product might feature high-quality wood veneer. As with all natural wood products, proper care is important for best results over the life of the product. Because of the nature of natural wood, you might see unique variations in the grain pattern or subtle variations in color, which are normal.

- Clean the wood with a dry, static-free microfiber cloth or chamois.
- Avoid cleaning products containing substances such as ammonia, methylene chloride, acetone, turpentine, or other petroleum-based solvents.
- Do not expose the wood to sun or moisture for long periods of time.
- If the wood becomes wet, dry it by dabbing with an absorbent, lint-free cloth.
- Avoid contact with any substance that might dye or discolor the wood.
- Avoid contact with sharp objects or rough surfaces that might scratch the wood.

See [Removing dirt and debris from your computer on page 23](#) for the recommended steps to clean the high-touch, external surfaces on your computer. After you remove the dirt and debris, you can also clean the surfaces with a disinfectant. See [Cleaning your computer with a disinfectant on page 24](#) for sanitizing guidelines to help prevent the spread of harmful bacteria and viruses.

Packaging and transporting guidelines

Follow these grounding guidelines when packaging and transporting equipment:

- To avoid hand contact, transport products in static-safe tubes, bags, or boxes.
- Protect ESD-sensitive parts and assemblies with conductive or approved containers or packaging.
- Keep ESD-sensitive parts in their containers until the parts arrive at static-free workstations.
- Place items on a grounded surface before removing items from their containers.
- Always be properly grounded when touching a component or assembly.
- Store reusable ESD-sensitive parts from assemblies in protective packaging or nonconductive foam.
- Use transporters and conveyors made of antistatic belts and roller bushings. Be sure that mechanized equipment used for moving materials is wired to ground and that proper materials are selected to avoid static charging. When grounding is not possible, use an ionizer to dissipate electric charges.

Accessing support information

To find the HP support that you need, use this information.

Table 4-3 Support information locations



Service consideration	Path to access information
<p>Records of reported failure incidents stored on the computer</p>	<p>Windows®:</p> <p>Preoperating system failures are logged in the BIOS Event Log. To view the BIOS Event Log:</p> <ol style="list-style-type: none"> 1. Press the power button. 2. Immediately and repeatedly press esc when the power button light turns white. <p>NOTE: If you do not press esc at the appropriate time, you must restart the computer and again repeatedly press esc when the power button light turns white to access the utility.</p> <ol style="list-style-type: none"> 3. Press f10 to enter the BIOS setup. 4. Complete one of these tasks: <ul style="list-style-type: none"> • (On commercial products) Under the Main tab, select BIOS event log, and then select View BIOS Event Log. • (On consumer products) Under the Main tab, select System Log. <p>Post-operating system failures are logged in the Event Viewer.</p> <ol style="list-style-type: none"> 1. Turn on the computer and allow the operating system to open. 2. Select the search icon  in the taskbar. 3. Type <code>Event Viewer</code>, and then press enter. 4. Select the log from the left panel. Details display in the right panel. <p>Chrome™:</p> <ol style="list-style-type: none"> 1. Go to support.google.com/chrome. 2. Search <code>collect Chrome device logs</code>.
<p>Technical bulletins</p>	<p>To locate technical bulletins:</p> <ol style="list-style-type: none"> 1. Go to www.hp.com. 2. Place the cursor over Problem solving to display more options. 3. Select Support & Troubleshooting. 4. Type the serial number, product number, or product name to go to the product support page. 5. Select Advisories to view technical bulletins.
<p>Repair professionals</p>	<p>To locate repair professionals:</p> <ol style="list-style-type: none"> 1. Go to www.hp.com. 2. Place the cursor over Support resources to display more options. 3. Select Authorized service providers.

Table 4-3 Support information locations (continued)

Service consideration	Path to access information
Component and diagnosis information, failure detection, and required action	To locate diagnosis information and actions: <ol style="list-style-type: none"><li data-bbox="703 310 1203 331">1. Go to http://www.hp.com/go/techcenter/pcdiags.<li data-bbox="703 363 938 384">2. Select Get Support.<li data-bbox="703 415 1445 457">3. Near the bottom of the window, select Notebook PCs, and then select your location.

5 Removal and replacement procedures for Customer Self-Repair parts

This chapter provides removal and replacement procedures for Customer Self-Repair parts.

 **NOTE:** The Customer Self-Repair program is not available in all locations. Installing a part that is not supported by the Customer Self-Repair program can void your warranty. Check your warranty to determine whether Customer Self-Repair is supported in your location.

 **NOTE:** The [HP Support YouTube Channel](#) (in English) has videos that provide step-by-step removal and replacement instructions for many common parts and models.

Component replacement procedures

To remove and replace computer components, use these procedures.

 **NOTE:** Details about your computer, including model, serial number, product key, and length of warranty, are on the service tag at the bottom of your computer.

 **NOTE:** HP continually improves and changes product parts. For complete and current information about supported parts for your computer, go to <https://partsurfer.hp.com/>, select your country or region, and then follow the on-screen instructions.

Make special note of each screw size and location during removal and replacement.

Preparation for disassembly

To remove and replace computer components, use these procedures:

For initial safety procedures, see [Removal and replacement procedures preliminary requirements on page 19](#).

1. Turn off the computer. If you are unsure whether the computer is off or in Hibernation or Sleep mode, turn the computer on, and then shut it down through the operating system.
2. Disconnect the power from the computer by unplugging the power cord from the computer.
3. Disconnect all external devices from the computer.

Battery

The battery removal procedure differs depending on whether you are removing and replacing the existing battery or installing a new battery. To install a new battery, you must use a revive kit.

- To remove and replace the existing battery, see [Removing and reinstalling the same battery on page 29](#).
- To install a new battery, see [Installing a new battery on page 30](#).

Removing and reinstalling the same battery

To remove the battery, use this procedure and illustration.

Table 5-1 Battery description and part number

Description	Spare part number
2 cell, 47 Whr, Li-ion battery	N85243-001

 **WARNING!** To avoid personal injury and damage to the product:

- Do *not* puncture, twist, or crack the battery.
- Do *not* cause an external puncture or rupture to the battery. Punctures can cause a short inside the battery, which can result in battery thermal runaway.
- Do *not* handle or touch the battery enclosure with sharp objects such as tweezers or pliers, which might puncture the battery.
- Do *not* compress or squeeze the battery case with tools or heavy objects stacked on top of the case. These actions can apply undue force to the battery.
- Do *not* touch the connectors with any metallic surface or object, such as metal tools, screws, or coins, which can cause shorting across the connectors.

Before removing the battery, follow these steps:

1. Prepare the computer for disassembly (see [Preparation for disassembly on page 28](#)).
2. Remove the bottom cover (see [Bottom cover on page 37](#)).

 **WARNING!** To reduce potential safety issues, use only the user-replaceable battery provided with the computer, a replacement battery provided by HP, or a compatible battery purchased from HP.

 **IMPORTANT:** Removing a battery that is the sole power source for the computer can cause loss of information. To prevent loss of information, save your work or shut down the computer through Windows before you remove the battery.

Remove the battery:

1. Lift the tape **(1)** off the system board battery connector. You do not need to completely remove the tape.
2. Disconnect the battery cable **(2)** from the system board.
3. Remove the four Phillips M2.0 × 5.0 screws **(3)** that secure the battery to the computer.

4. Remove the battery from the computer (4).

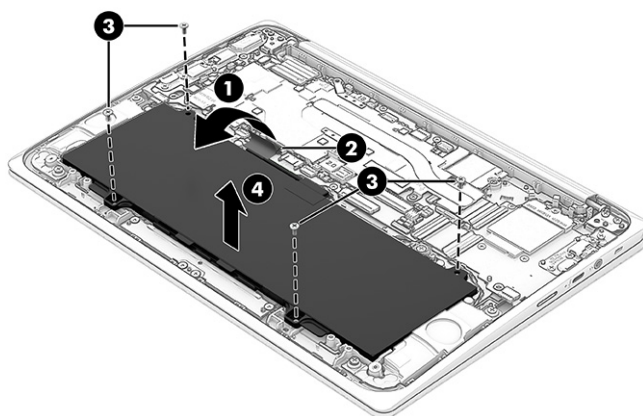

To reinstall the battery, reverse the removal procedures.



NOTE: When replacing the battery, be sure to completely reassemble the computer and plug in the AC adapter before turning the computer on.

Installing a new battery

To replace the battery, use these procedures and illustrations. You must use a revive kit to remove the old battery and install a new one. The revive kit includes an empty containment tray and a containment tray with a battery preinstalled.

Table 5-2 Battery description and part number

Description	Spare part number
3 cell, 41 Whr, Li-ion battery	P22940-001

Before starting this replacement procedure:

- Ensure other individuals are sufficiently clear of your workspace.
- Ensure your workspace is clear of any flammable material such as paper or oils.
- Locate the nearest ABC dry chemical fire-extinguisher for use in an emergency.



WARNING! This procedure requires removing the battery or disconnecting the battery cable. Use care to avoid bending, twisting, or puncturing the battery regardless of its condition. Failure to follow this replacement guide or to use HP recommended tools might damage the system and/or cause a safety hazard.

- Do *not* remove the battery from the containment tray.
- Do *not* handle or touch the battery enclosure with sharp objects such as tweezers or pliers, which might puncture the battery.
- Do *not* touch the connectors with any metallic surface or object, such as metal tools, screws, or coins, which can cause shorting across the connectors.

Should a part become stuck or difficult to remove when opening a unit where a swollen battery is suspected, or if the battery becomes stuck in the unit, stop, and contact HP Support for assistance. Do not try to remove a battery by force.

 **NOTE:** Screw locations, latch locations, and internal components might vary.

Before removing the battery, follow these steps:

1. Prepare the computer for disassembly (see [Preparation for disassembly on page 28](#)).
2. Remove the bottom cover (see [Bottom cover on page 37](#)).

 **WARNING!** To reduce potential safety issues, use only the user-replaceable battery provided with the computer, a replacement battery provided by HP, or a compatible battery purchased from HP.

 **IMPORTANT:** Removing a battery that is the sole power source for the computer can cause loss of information. To prevent loss of information, save your work or shut down the computer through Windows before you remove the battery.

Remove the battery:

1. To remove the battery using the revive kit:
 - a. Open the empty battery containment tray.



- b. Remove the backing from the adhesive on the tray.

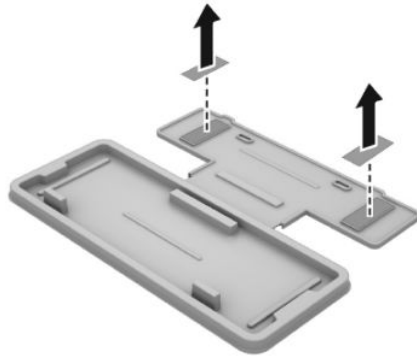

- c. Turn the tray (1) over so that the adhesive is facing down.
- d. Place the tray (2) centered on the battery.
- e. Press down on the indentations on the tray (3) to adhere it to the battery.

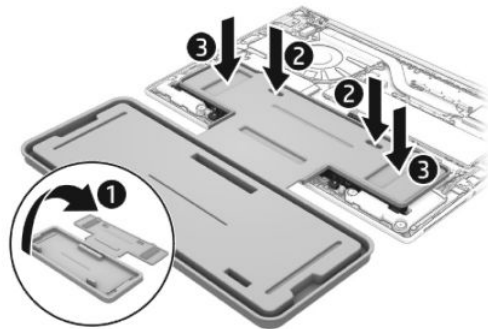

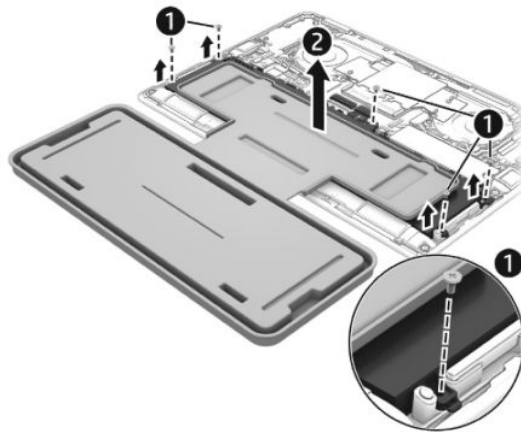

- f. Remove the Phillips screws (1) that secure the battery to the computer. Screw locations might vary.

- g. Lift the top of the tray (2) to remove the battery from the computer.

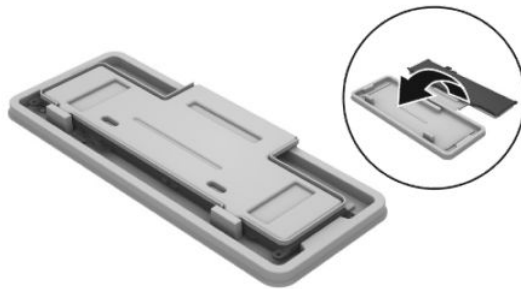

- h. Rotate the battery up and over into the cavity of the containment tray.



 **NOTE:** Please recycle responsibly. For more information about recycling programs, see the HP website at <http://www.hp.com/recycle>.

2. To install the battery using the revive kit:
- a. Open the containment tray that includes the new battery.

 **IMPORTANT:** If conductive tape was included with the new battery, you must paste the conductive tape over the metal plates on the battery as shown below before installation. If conductive tape was not included with the new battery, you can skip this step.

Metal plates on the battery

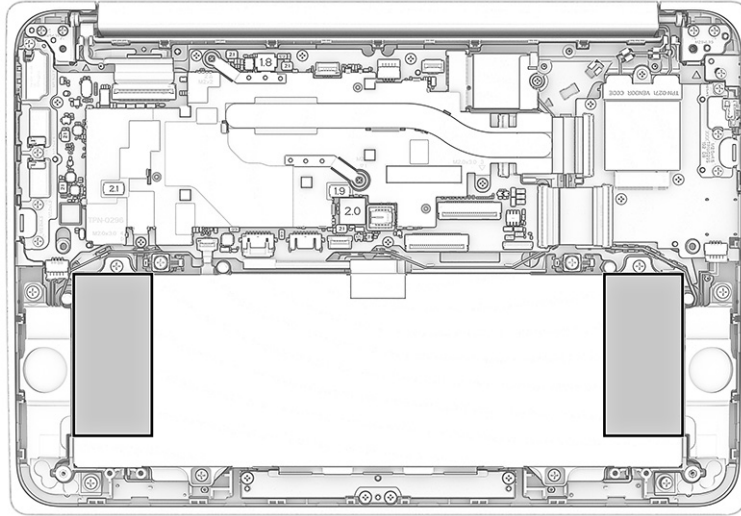

Metal plates covered by conductive tape

 **NOTE:** Be sure to align the conductive tape over the battery starting from the side of the battery.

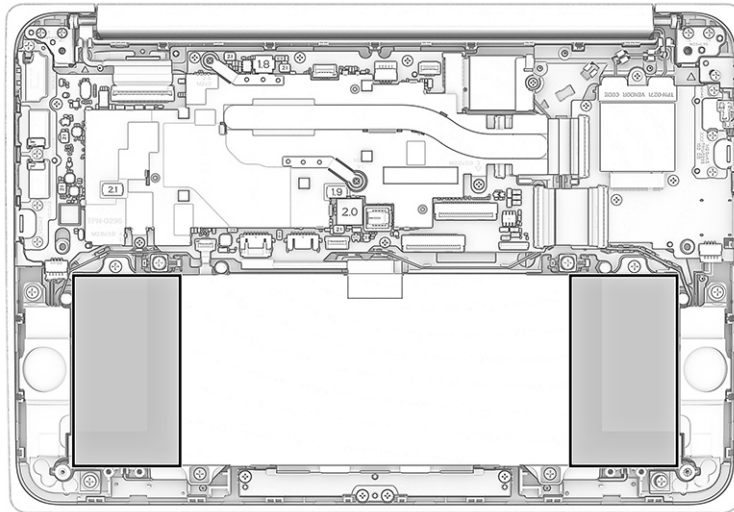

If the metal plates are located at the bottom of the battery, place the conductive tape over them as shown.

Metal plates at the bottom of the battery

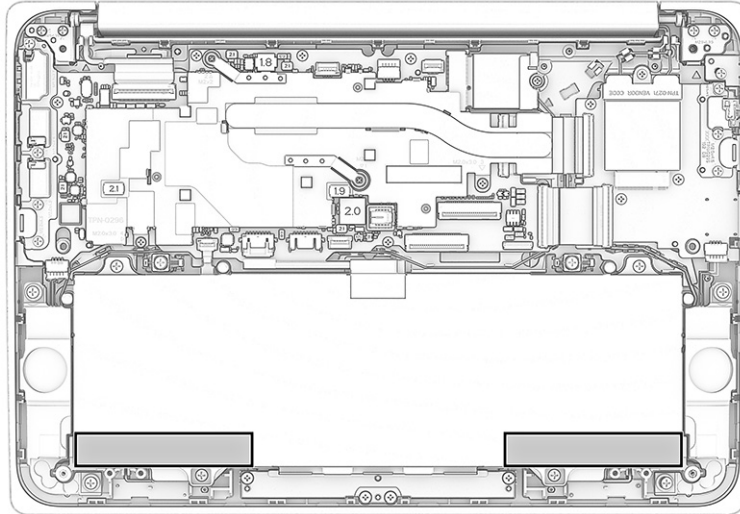

- b. Turn the tray **(1)** over so the battery is facing downward, and then insert the battery **(2)** into the computer.



NOTE: To avoid damage when inserting the battery into the computer, be sure that the power connector on the battery lines up and successfully mates with the connector on the system board.

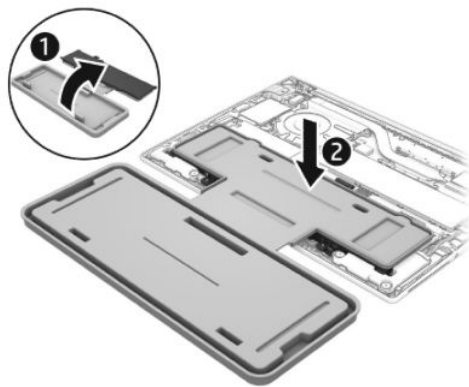

- c. Install the screws **(1)** to secure the battery. Screw locations might vary.

- d. Lift the containment tray (2) off the battery,

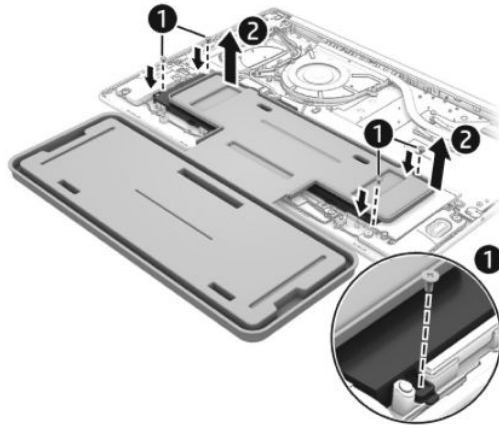



NOTE: When replacing the battery, be sure to completely reassemble the computer and plug in the AC adapter before turning the computer on.

6 Removal and replacement procedures for authorized service provider parts

This chapter provides removal and replacement procedures for authorized service provider parts.

 **IMPORTANT:** Only an authorized service provider should access the components described in this chapter. Accessing these parts can damage the computer or void the warranty.

 **NOTE:** Details about your computer, including model, serial number, product key, and length of warranty, are on the service tag at the bottom of your computer.

 **NOTE:** The [HP Support YouTube Channel](#) (in English) has videos that provide step-by-step removal and replacement instructions for many common parts and models.

Component replacement procedures

To remove and replace computer components, use the procedures described in this section.

 **NOTE:** HP continually improves and changes product parts. For complete and current information about supported parts for your computer, go to <https://partsurfer.hp.com/>, select your country or region, and then follow the on-screen instructions.

Make special note of each screw size and location during removal and replacement.

Preparation for disassembly

To remove and replace computer components, use these procedures:

For initial safety procedures, see [Removal and replacement procedures preliminary requirements on page 19](#).

1. Turn off the computer. If you are unsure whether the computer is off or in Hibernation or Sleep mode, turn the computer on, and then shut it down through the operating system.
2. Disconnect the power from the computer by unplugging the power cord from the computer.
3. Disconnect all external devices from the computer.

Bottom cover

To remove the bottom cover, use this procedure and illustration.

Table 6-1 Bottom cover descriptions and part numbers

Description	Spare part number
Models with WWAN	N90972-001
Models without WWAN	N90971-001

Before removing the bottom cover, prepare the computer for disassembly ([Preparation for disassembly on page 28](#)).

Remove the bottom cover:

1. Position the computer upside down with the front toward you.
2. Remove the five Phillips M2.0 × 8.0 screws (1) that secure the bottom cover to the computer.
3. Remove the four Phillips M2.0 × 5.0 screws (2) that secure the bottom cover to the computer.

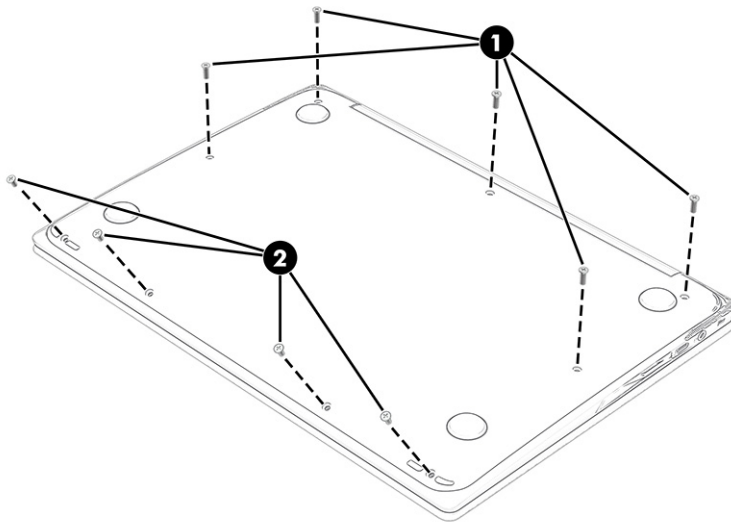

4. Use a case utility tool or similar thin plastic tool (1) to separate the top edge of the bottom cover from the computer.
5. Remove the bottom cover (2).

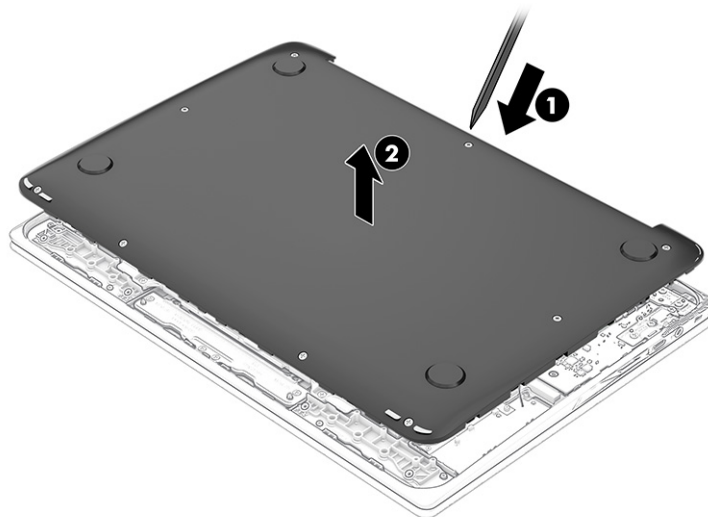

To install the bottom cover, reverse the removal procedures.

Display subcomponents (without removing the display)

You can remove some display subcomponents without removing the entire display assembly from the computer. To remove the display panel and camera module, use these procedures and illustrations.

To remove display subcomponents that require that you remove the display from the computer, see [Display assembly on page 53](#).

Before removing the display subcomponents, follow these steps:

1. Prepare the computer for disassembly ([Preparation for disassembly on page 28](#)).
2. Remove the bottom cover (see [Bottom cover on page 37](#)).
3. Disconnect the battery cable from the system board.

Remove the display assembly subcomponents:

 **NOTE:** The display assembly can remain attached to the computer for these procedures.

1. To remove the display panel:
 - a. Open the computer to 90°.
 - b. Release the top, left, and right sides of the bezel from the display.

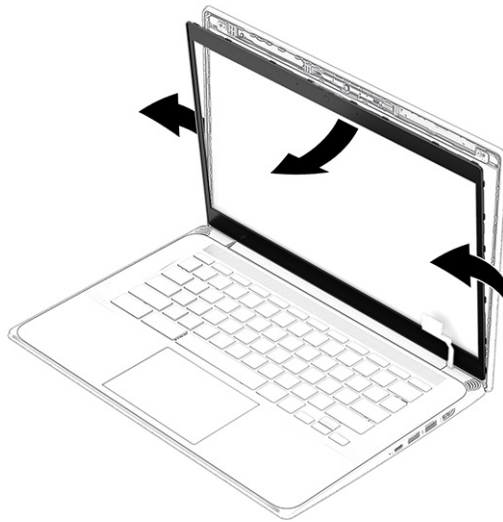

- c. Insert a tool under the bottom of the bezel and pull the tool along the length of the bezel to release it.

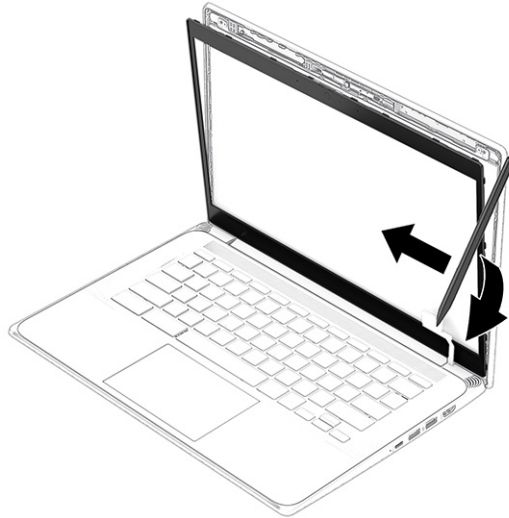

- d. Open the computer to 180°.
- e. Remove the bezel from the display panel.

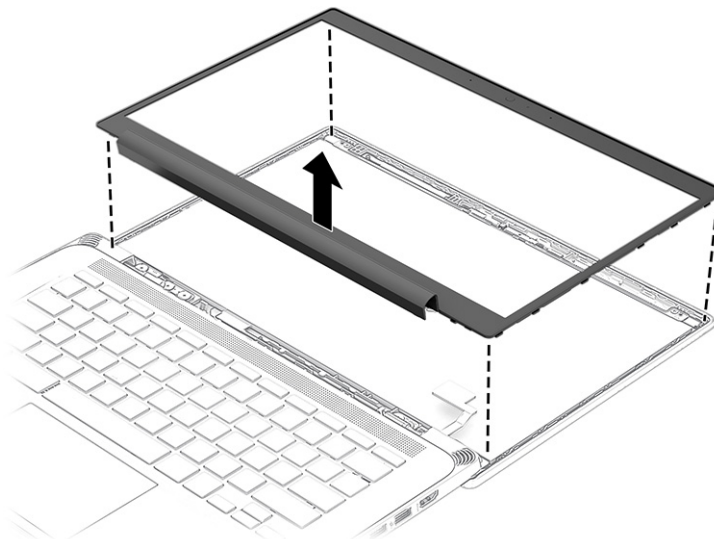

The display bezel is available as spare part number N84553-001.

- f. The display panel is secured to the display enclosure with tape that is installed in four locations under the panel. To remove the panel, use tweezers to grasp the end of each piece of tape (1). Turn and wrap the tape around the tweezers (2) as you continue to pull the tape out from behind the display panel (3). You must pull the tape multiple times before it is completely removed.



NOTE: Pull the tape out slowly and evenly to prevent it from breaking prematurely.

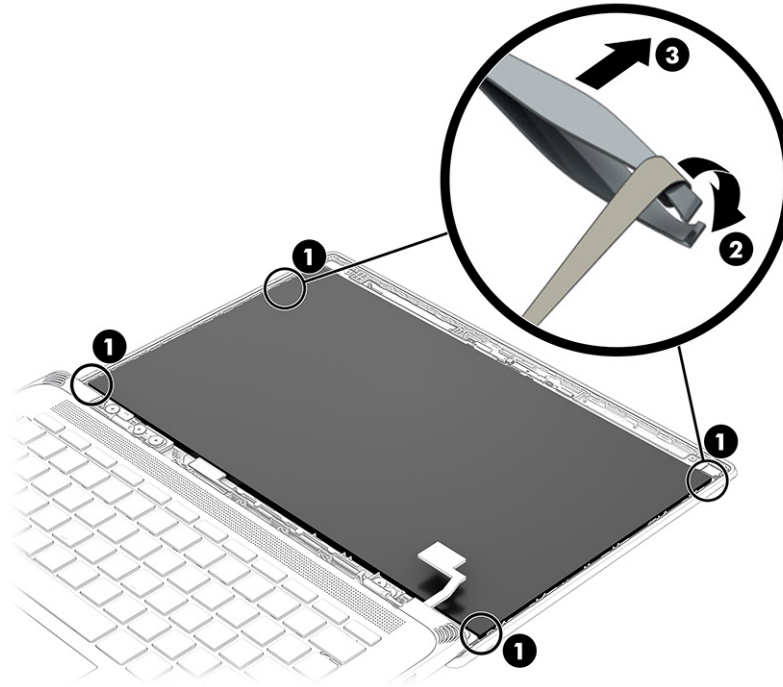

Display panels are available as the following spare part numbers:

N83264-001: FHD, 300 nits, WWAN

N83266-001: FHD, 250 nits, touch screen

N83269-001: FHD, 250 nits

N83268-001: HD, 250 nits

N83271-001: HD, 250 nits, touch screen

- g.** When installing a display panel, use the following illustration to determine tape installation locations on the inside of the display rear cover.

 **NOTE:** When installing the tape onto the display rear cover, be sure that the end of the tape is visible and accessible, and extends out slightly from under the installed display panel.

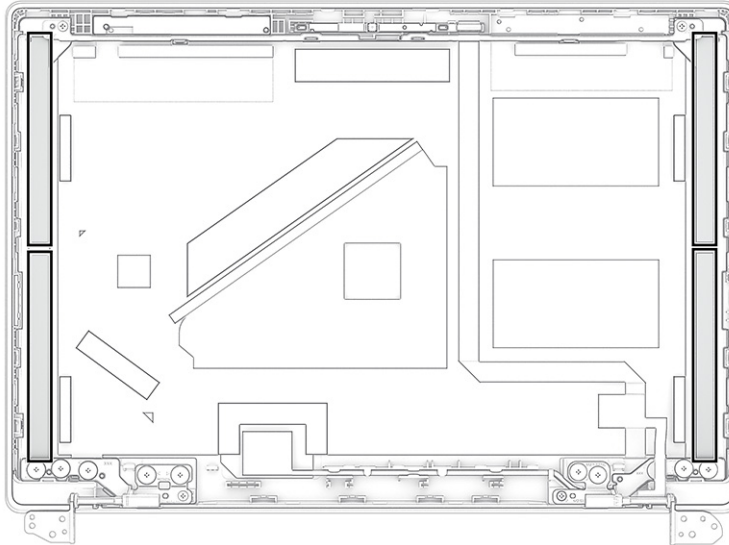

2. To remove the camera module:
 - a. Disconnect the cable (1) from the ZIF connector on the camera module.
 - b. Use a thin pry tool (2) to release the module.
 - c. Remove the camera module (3) from the display.

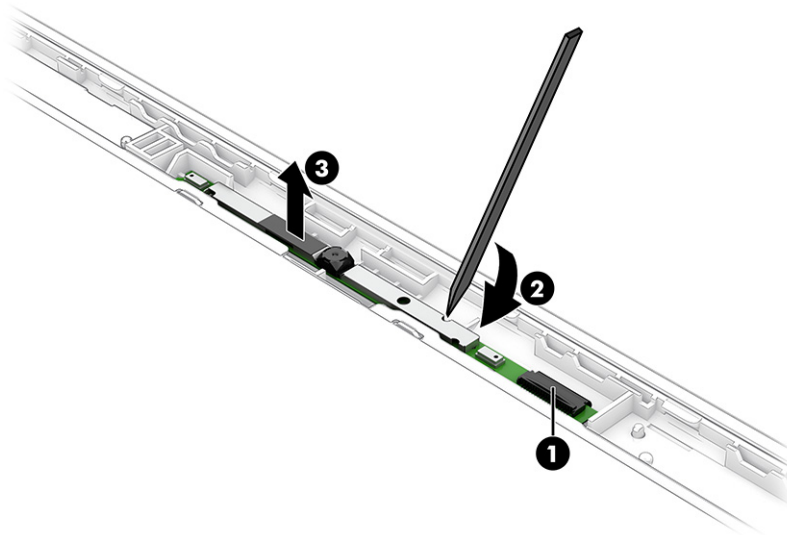

The camera module is available as spare part number N84552-001.

To install the display components with the display attached to the computer, reverse these procedures.

Speaker

To remove the speaker, use this procedure and illustration.

Table 6-2 Speaker description and part number

Description	Spare part number
Speaker	N84548-001

Before removing the speaker, follow these steps:

1. Prepare the computer for disassembly ([Preparation for disassembly on page 28](#)).
2. Remove the bottom cover (see [Bottom cover on page 37](#)).
3. Disconnect the battery cable from the system board.

Remove the speaker:

1. Lift the tape **(1)** off the speaker connector on the system board. You do not have to completely remove the tape.
2. Disconnect the speaker cable **(2)** from the system board.
3. Remove the two Phillips M1.6 × 2.5 screws **(3)** from the speaker.
4. Remove the speaker **(4)** from the computer.

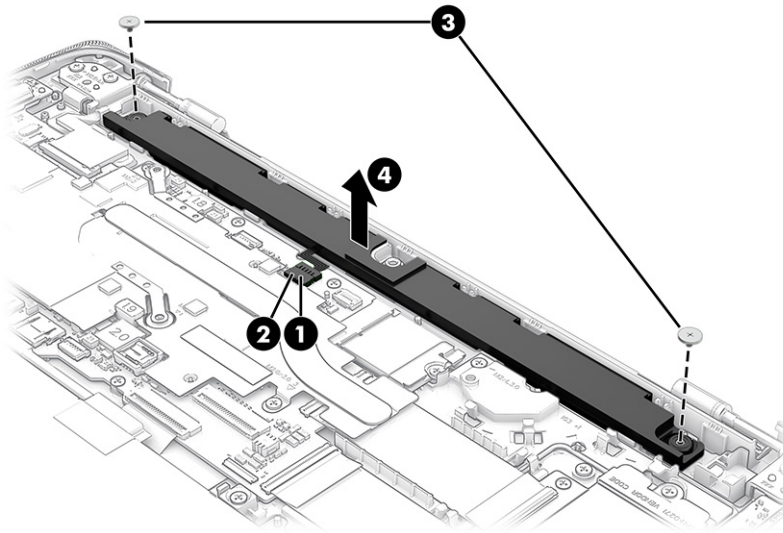

To install the speaker, reverse this procedure.

WWAN module

To remove the WWAN module, use this procedure and illustration.

Table 6-3 WWAN module descriptions and part numbers

Description	Spare part number
WWAN module (Qualcomm Snapdragon X12 LTE-Advanced [CAT 6])	N42576-005

 **IMPORTANT:** To prevent an unresponsive system, replace the wireless module only with a wireless module authorized for use in the computer by the governmental agency that regulates wireless devices in your country or region. If you replace the module and then receive a warning message, remove the module to restore device functionality, and then contact technical support.

Before removing the WWAN module, follow these steps:

1. Prepare the computer for disassembly ([Preparation for disassembly on page 28](#)).
2. Remove the bottom cover (see [Bottom cover on page 37](#)).
3. Disconnect the battery cable from the system board (see [Battery on page 28](#)).

Remove the WWAN module:

1. Remove the Phillips M2.0 × 3.0 screw (1) that secures from the bracket on the WWAN module, and then remove the bracket (2).
2. Disconnect the antenna cables from the terminals (3) on the WWAN module.
3. Remove the WWAN module by pulling the module away from the slot at an angle (4).

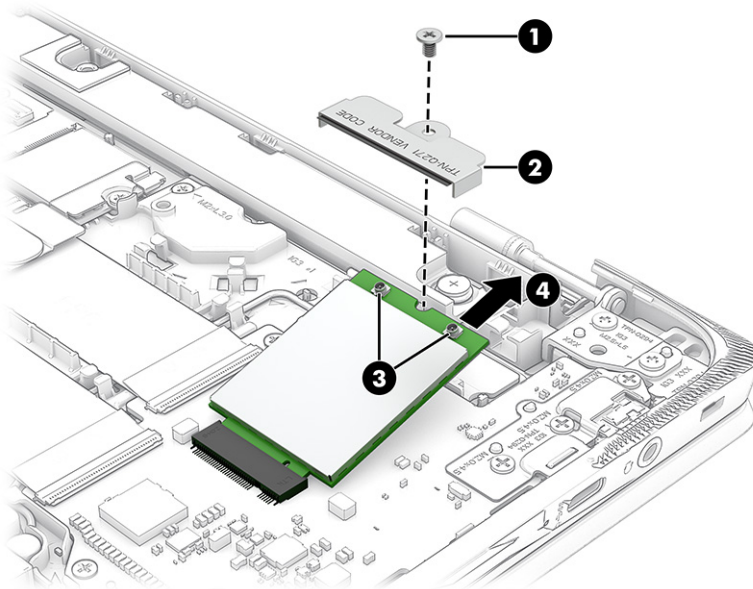

4. If the WWAN antenna is not connected to the terminal on the WWAN module, a protective sleeve must be installed on the antenna connector, as shown in the following illustration.

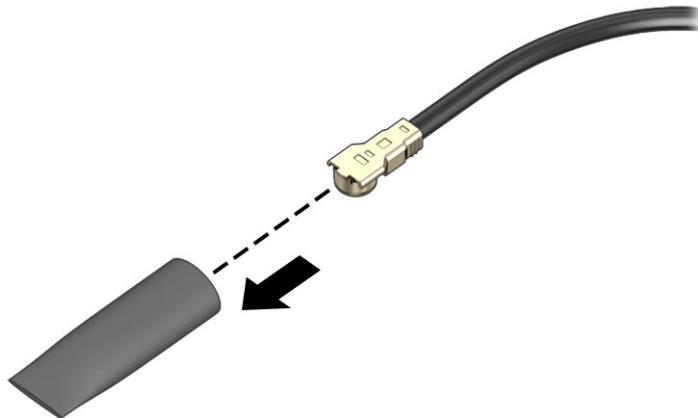

To install the WWAN module, reverse this procedure.

USB board

To remove the USB board, use these procedures and illustrations.

Table 6-4 USB board descriptions and part numbers

Description	Spare part number
Models with WWAN	N84546-001
Models without WWAN	N84547-001

Before removing the USB board, follow these steps:

1. Prepare the computer for disassembly ([Preparation for disassembly on page 28](#)).
2. Remove the bottom cover (see [Bottom cover on page 37](#)).
3. Disconnect the battery cable from the system board.

Remove the USB board:

1. Lift the tape **(1)** from the two connectors on the USB board. You do not have to completely remove the tape.
2. Disconnect the cables from the two reverse ZIF connectors **(2)** on the board.
3. Remove the two Phillips M2.0 × 3.0 screws **(3)** and the three Phillips M2.0 × 4.5 screws **(4)** from the board.
4. Remove the bracket **(5)** from the board
5. Remove the SIM card holder **(6)** on the side of the computer.

- Lift the inside of the board up first, and then pull board (7) into computer and up to remove it

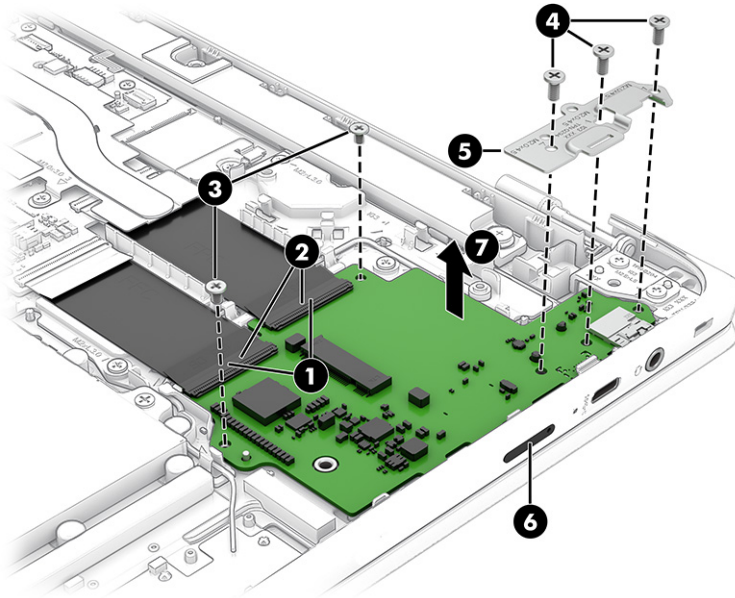

- When replacing the USB board, be sure to remove the USB bracket from the old board and install it onto the new board. To remove the USB bracket (1) from the USB board, pull the bracket straight off (2) the board.

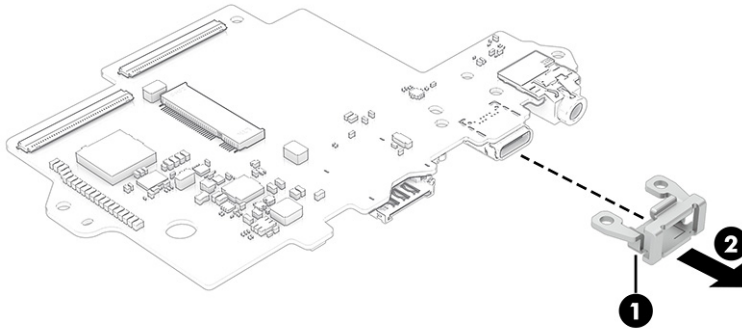

To install the USB bracket onto the USB board, remove the paper cover from the tape on the inside of the bracket, and then slide the bracket onto the USB port on the USB board.

To install the USB board, reverse this procedure.

WLAN module

To remove the WLAN module, use this procedure and illustration.

Table 6-5 WLAN module descriptions and part numbers

Description	Spare part number
Intel AX211 Wi-Fi 6E Bluetooth 5.3 WLAN	M53366-005

Table 6-5 WLAN module descriptions and part numbers (continued)

Description	Spare part number
MediaTek MT7921 Wi-Fi 6 + Bluetooth 5.3	M74879-005

 **IMPORTANT:** To prevent an unresponsive system, replace the wireless module only with a wireless module authorized for use in the computer by the governmental agency that regulates wireless devices in your country or region. If you replace the module and then receive a warning message, remove the module to restore device functionality, and then contact technical support.

Before removing the WLAN module, follow these steps:

1. Prepare the computer for disassembly ([Preparation for disassembly on page 28](#)).
2. Remove the bottom cover (see [Bottom cover on page 37](#)).
3. Disconnect the battery cable from the system board.

Remove the WLAN module:

1. Remove the Phillips M2.0 × 3.0 screw (1) that secures from the bracket on the WLAN module, and then remove the bracket (2).
2. Disconnect the antenna cables from the module terminals (3).
3. Remove the module (4) by pulling the it away from the slot at an angle.

 **NOTE:** WLAN modules are notched to prevent incorrect installation.

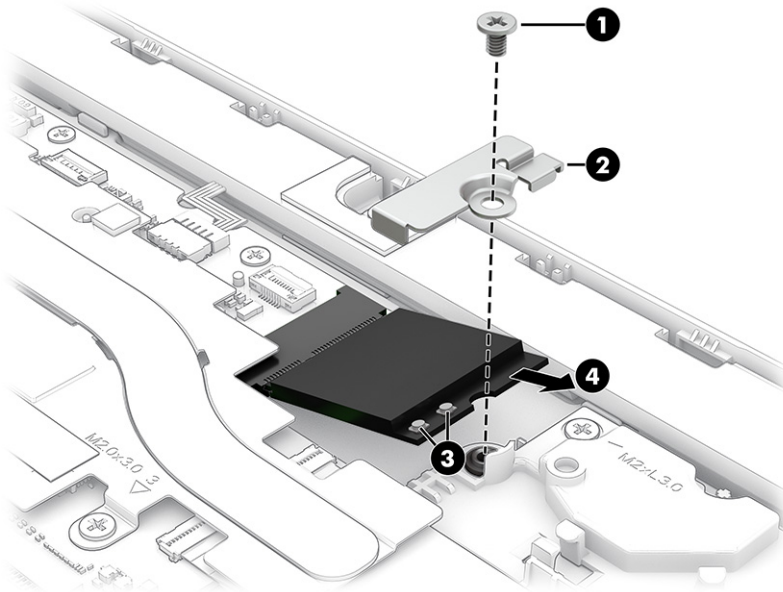

4. If the WLAN antenna is not connected to the terminal on the WLAN module, install a protective sleeve on the antenna connector, as shown in the following illustration.

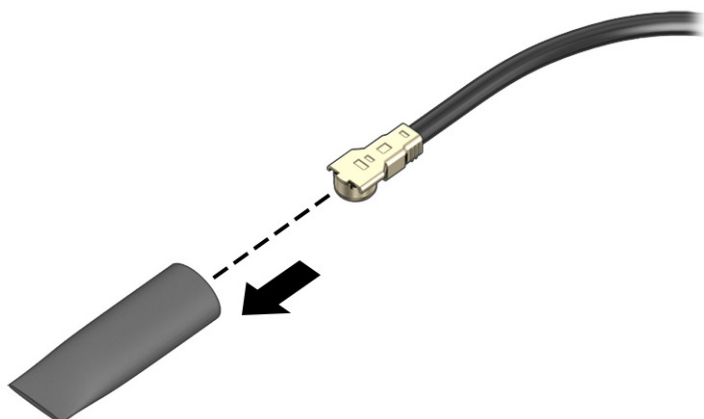

To install the WLAN module, reverse this procedure.

Touchpad

To remove the touchpad, use this procedure and illustration.

Table 6-6 Touchpad description and part number

Description	Spare part number
Touchpad	N84551-001

Before removing the touchpad, follow these steps:

1. Prepare the computer for disassembly (see [Preparation for disassembly on page 28](#)).
2. Remove the bottom cover (see [Bottom cover on page 37](#)).
3. Remove the battery.

Remove the touchpad:

1. Remove the four Phillips M2.0 × 2.5 screws (1) from the touchpad bracket, and then remove the bracket (2).

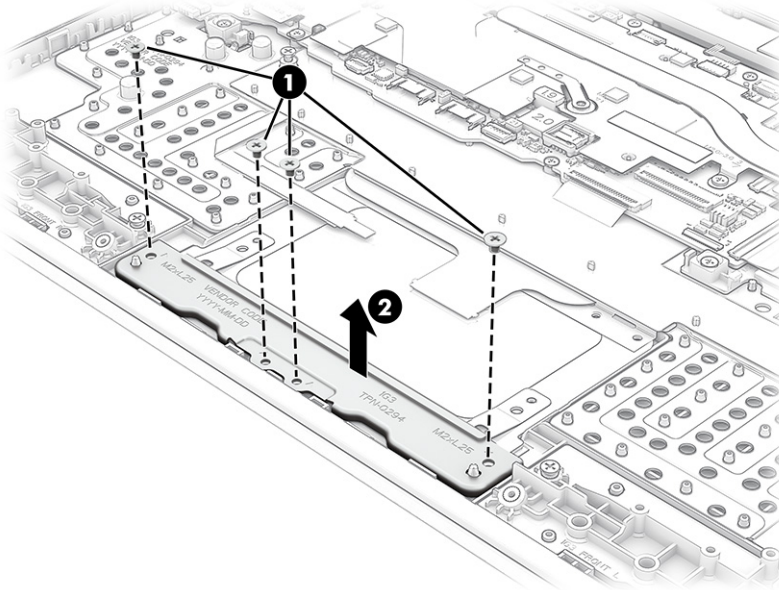

2. Remove the tape (1) from the top of the touchpad.
3. Disconnect the cable from the ZIF connector (2) on the touchpad.
4. Lift the tape (3) that covers the screws at the top of the touchpad.
5. Remove the three Phillips M2.0 × 2.0 screws (4) from the touchpad.
6. Remove the touchpad (5) from the computer.

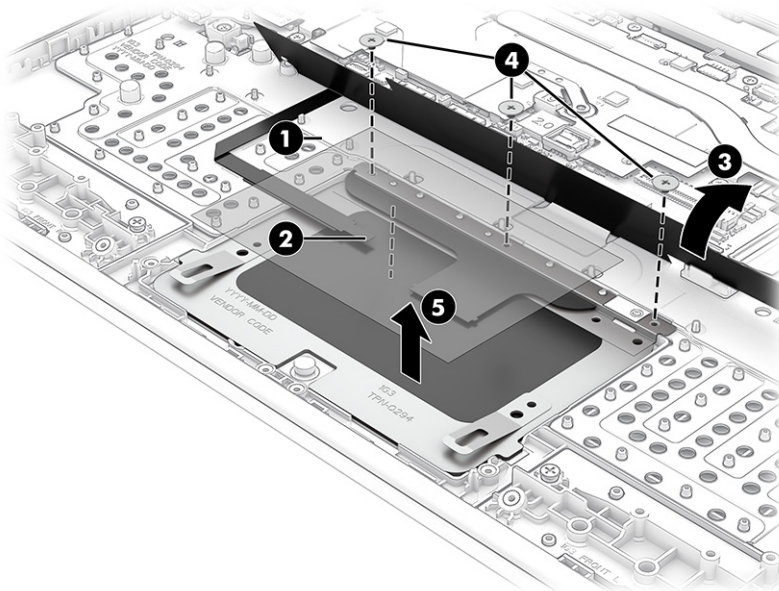

To install the touchpad, reverse this procedure.

Heat sink

To remove the heat sink, use these procedures and illustrations.

Table 6-7 Heat sink descriptions and part numbers

Description	Spare part number
Heat sink (includes replacement thermal material)	N87095-001
Heat sink thermal pad	M76797-001

Before removing the heat sink, follow these steps:

1. Prepare the computer for disassembly ([Preparation for disassembly on page 28](#)).
2. Remove the bottom cover (see [Bottom cover on page 37](#)).
3. Disconnect the battery cable from the system board.

Remove the heat sink:

1. Remove the two Phillips M2.0×3.0 screws (1) and the two Phillips M2.0×2.0 broad head screws (2) that secure the heat sink to the system board.
2. Remove the heat sink (3).

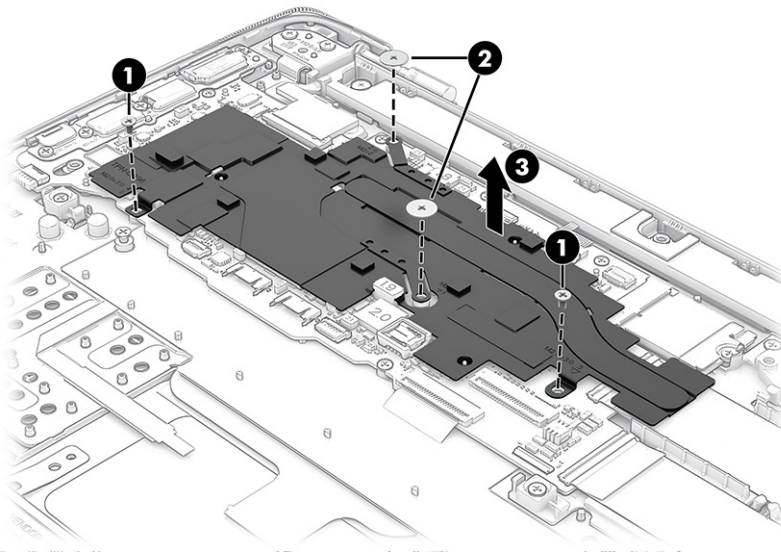

- Each time the heat sink is removed, thoroughly clean and replace the thermal material from the surface of the heat sink. Replacement thermal material is included with the heat sink and system board spare part kits.

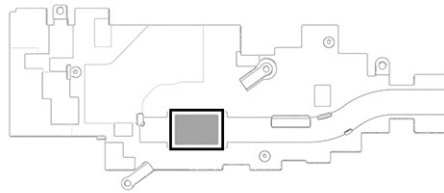

Reverse this procedure to install the heat sink.

System board

To remove the system board, use these procedures and illustrations.

Table 6-8 System board descriptions and part numbers

Description	Spare part number
System board (includes the processor, replacement thermal material, and the Chrome operating system)	
Intel N200 processor, 16 GB system memory, 128 GB UFS memory	N83261-001
Intel N200 processor, 16 GB system memory, 128 GB UFS memory (WWAN models)	N83262-001
Intel N200 processor, 8 GB system memory, 64 GB eMMC memory	N83263-001
Intel N100 processor, 16 GB system memory, 128 GB UFS memory	N83256-001
Intel N100 processor, 8 GB system memory, 64 GB eMMC memory	N83259-001
Intel N100 processor, 8 GB system memory, 64 GB eMMC memory (WWAN models)	N83260-001
Intel N100 processor, 4 GB system memory, 32 GB eMMC memory	N83257-001
Intel N100 processor, 4 GB system memory, 32 GB eMMC memory (WWAN models)	N83258-001

Before removing the system board, follow these steps:

- Prepare the computer for disassembly ([Preparation for disassembly on page 28](#)).
- Remove the bottom cover (see [Bottom cover on page 37](#)).
- Remove the battery.
- Remove the WLAN module (see [WLAN module on page 46](#)).

Remove the system board:

- Disconnect the following cables from the system board:
 - Display cable (ZIF) **(1)**
 - Speaker cable **(2)**
 - Daughter board cable (ZIF) from the USB board **(3)**

- Daughter board cable (ZIF) from the USB board **(4)**
- Keyboard cable (ZIF) **(5)**
- Touchpad cable (ZIF) **(6)**

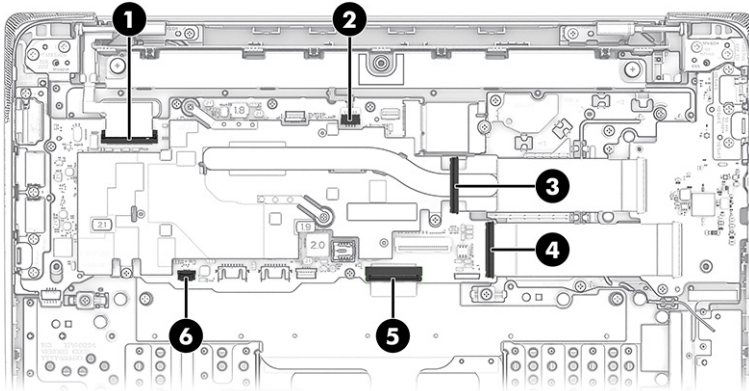

2. Remove the seven Phillips M2.0 × 3.0 screws **(1)** that secure the system board to the computer.
3. Remove the four Phillips M2.0 × 4.5 screws **(2)** that secure the system board to the computer.
4. Remove the bracket **(3)** from the system board.

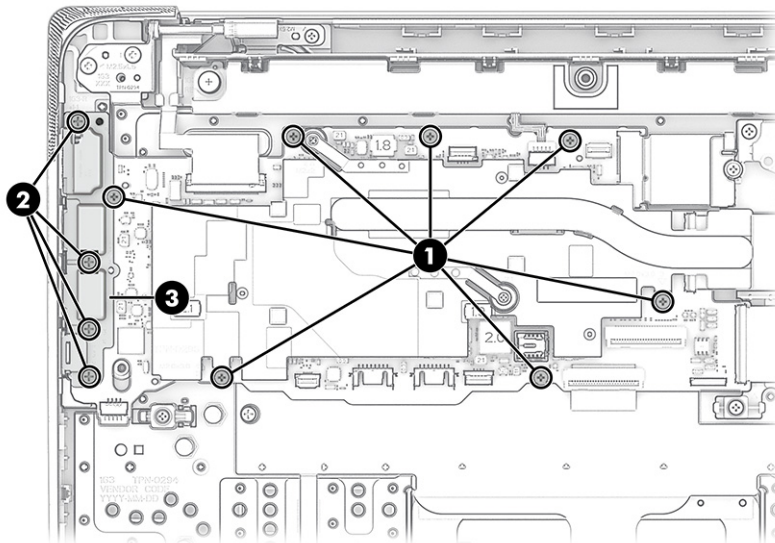

5. Lift the right side of the system board **(1)** until it rests at an angle.

6. Remove the system board (2) by pulling it right and out of the computer.

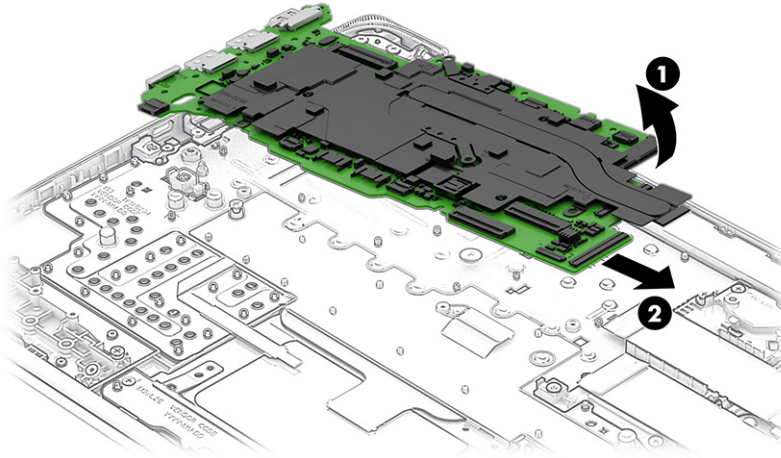

7. When replacing the system board, be sure to remove the USB bracket from the old board and install it onto the new board. To remove the USB bracket (1) from the system board, pull the bracket straight off (2) the board.

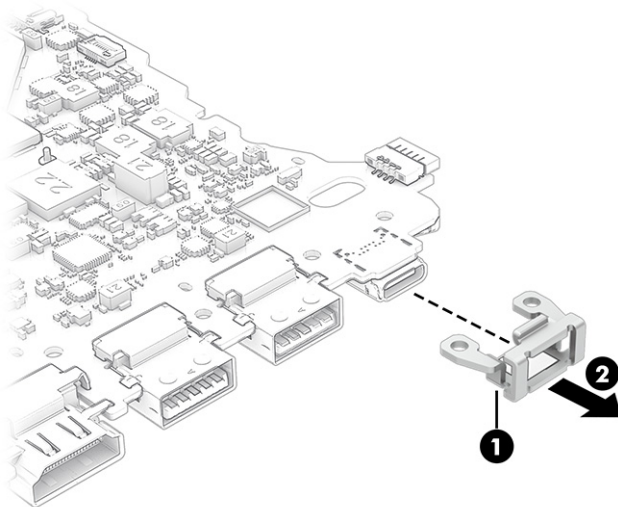

To install the USB bracket onto the system board, remove the paper cover from the tape on the inside of the bracket, and then slide the bracket onto the USB port on the system board.

To install the system board, reverse this procedure.

Display assembly

To remove and disassemble the display assembly, use these procedures and illustrations.

 **NOTE:** The display assembly is spared at the subcomponent level. For display assembly spare part information, see the individual removal subsections.

Before removing the display panel, follow these steps:

1. Prepare the computer for disassembly ([Preparation for disassembly on page 28](#)).

2. Remove the bottom cover (see [Bottom cover on page 37](#)).
3. Disconnect the battery cable from the system board.

Remove the display assembly:

1. Remove the four Phillips M2.5 × 5.0 screws (1) that secure the display assembly to the computer.
2. Lift the tape (2) that covers the display connector on the system board, and then disconnect the display cable (3) from the ZIF connector on the system board. You do not have to completely remove the tape from the connector.

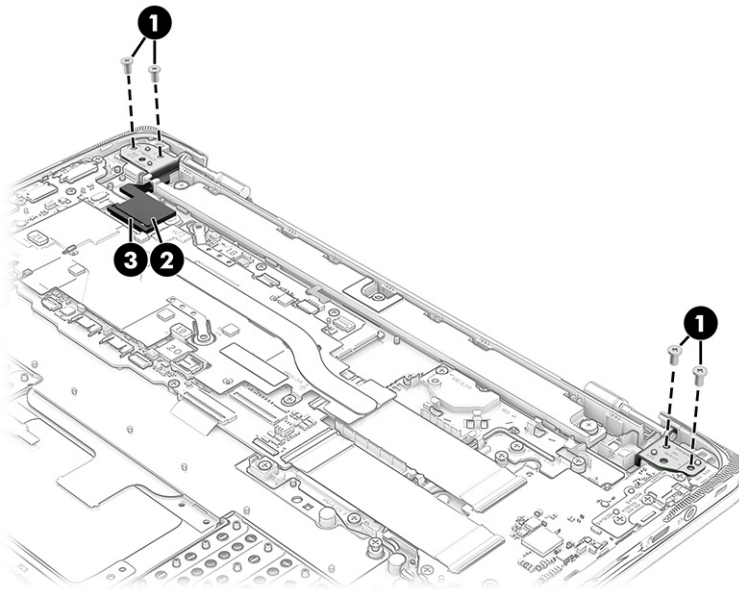

3. Open the display to 90° (1), and then separate the display (2) from the computer.

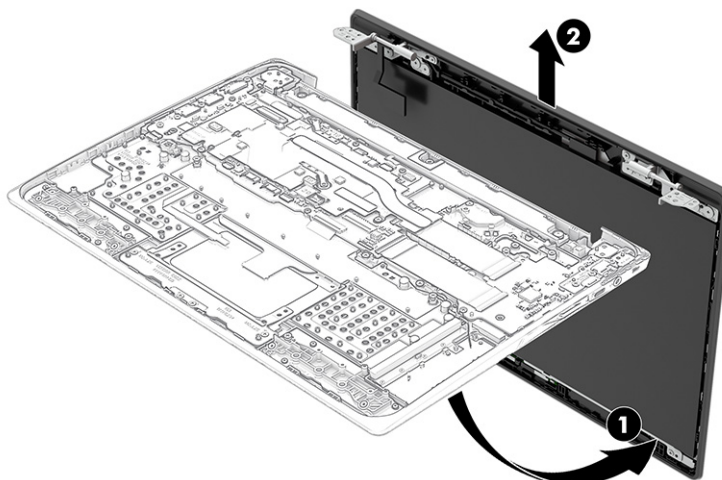

4. To remove the display panel from the display assembly:

- a. Release the top, left, and right sides of the bezel from the display.

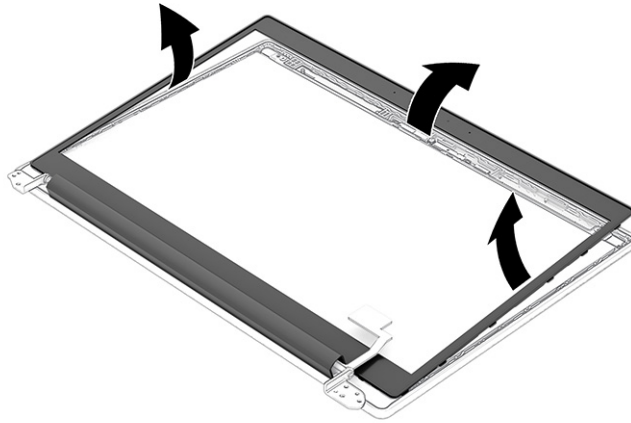

- b. Insert a tool under the bottom of the bezel and pull the tool along the length of the bezel to release it.

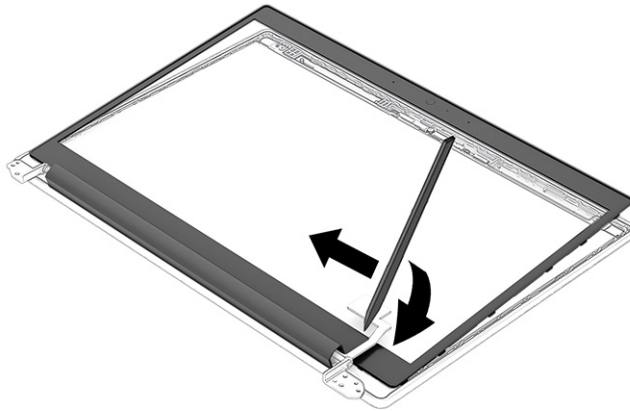

- c. Remove the bezel from the display panel.

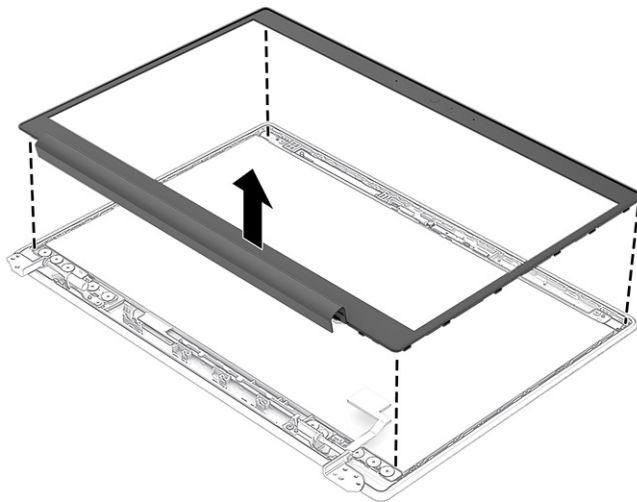

The display bezel is available as spare part number N84553-001.

- d. The display panel is secured to the display enclosure with tape that is installed in four locations under the panel. To remove the panel, use tweezers to grasp the end of each piece of tape (1). Turn and wrap the tape around the tweezers (2) as you continue to pull the tape out from behind the display panel (3). You must pull the tape multiple times before it is completely removed.

 **NOTE:** Pull the tape out slowly and evenly to prevent it from breaking prematurely.

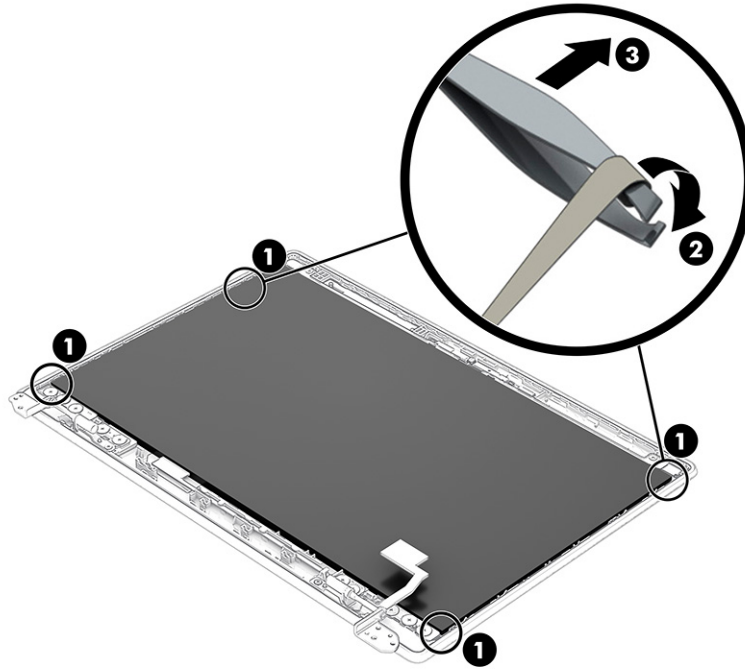

Display panels are available as the following spare part numbers:

N83264-001: FHD, 300 nits, WWAN

N83266-001: FHD, 250 nits, touch screen

N83269-001: FHD, 250 nits

N83268-001: HD, 250 nits

N83271-001: HD, 250 nits, touch screen

- e. When installing a display panel, use the following illustration to determine tape installation locations on the inside of the display rear cover.

 **NOTE:** When installing the tape onto the display rear cover, be sure that the end of the tape is visible and accessible, and extends out slightly from under the installed display panel.

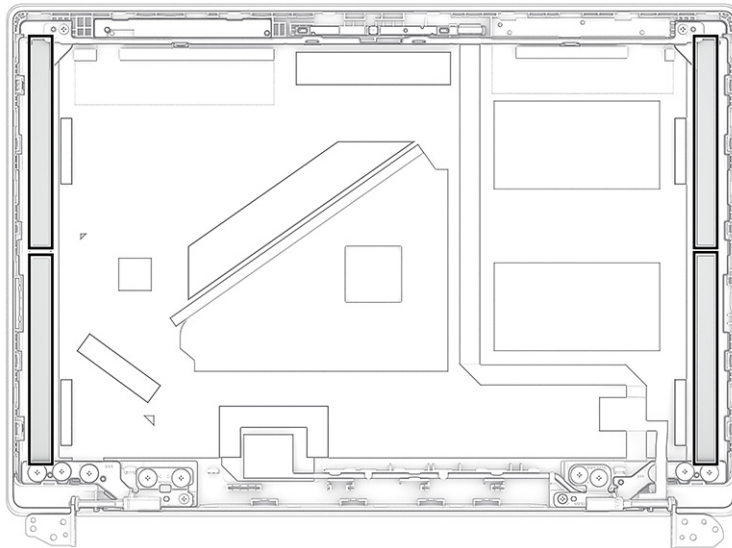

5. To remove the camera module:
 - a. Disconnect the cable from the ZIF connector **(1)** on the camera module.
 - b. Use a thin pry tool **(2)** to release the module.
 - c. Remove the camera module **(3)** from the display.

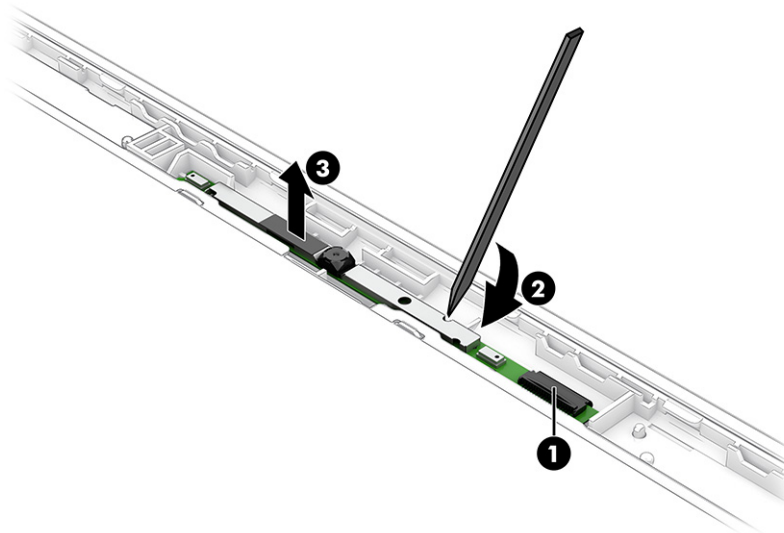

The camera module is available as spare part number N84552-001.

6. To remove the hinges from the display rear cover:
 - a. Remove the five Phillips M2.0 × 3.0 broad head screws **(1)** and the Phillips M2.0 × 3.0 screw **(2)** from each hinge.

- b. Remove the hinges (3) from the display back cover.

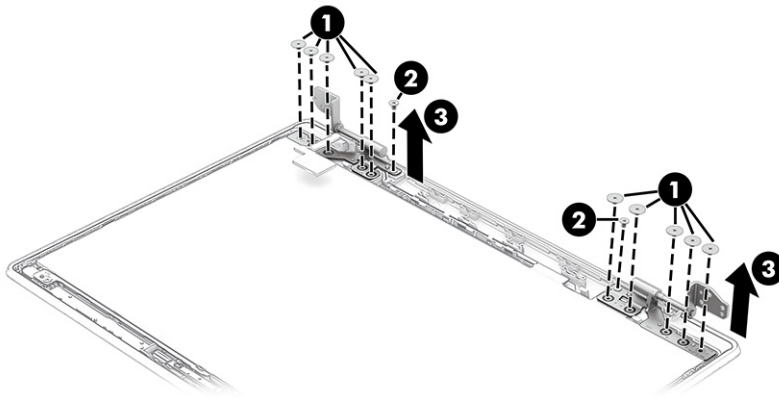

The display hinges are available as spare part number N84550-001.

7. Remove the two Phillips M2.0 × 3.0 screws (1) from the top display bracket, and then remove the bracket (2) from the display back cover.

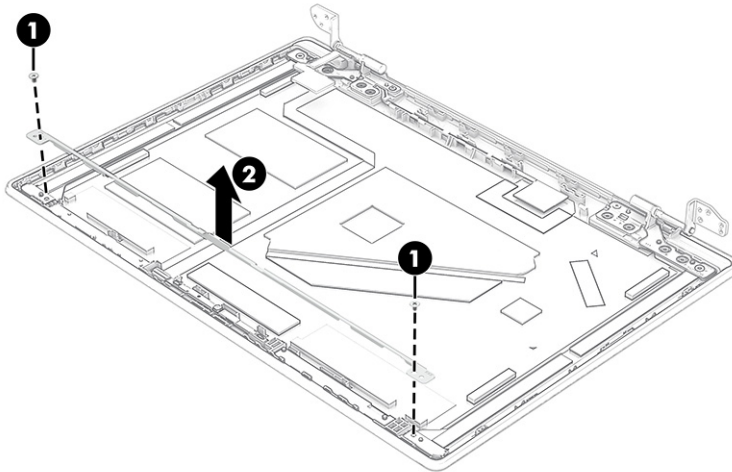

8. To remove the camera cable, disconnect the cable from the ZIF connector (1) on the camera module. Peel the cable (2) off the inside of the display rear cover, and then remove the cable from the clips (3) along the bottom right of the display rear cover.

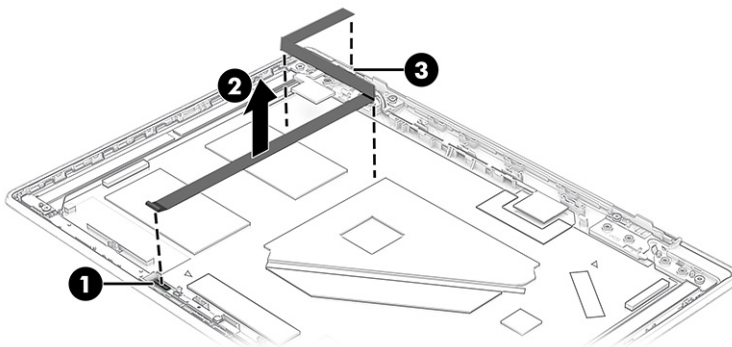

9. To remove the display cable, remove the cable from the clips **(1)** along the bottom of the display rear cover. Peel the flat part of the cable **(2)** off the inside of the display rear cover, and then remove the cable from the clip **(3)** at the bottom of the display rear cover.

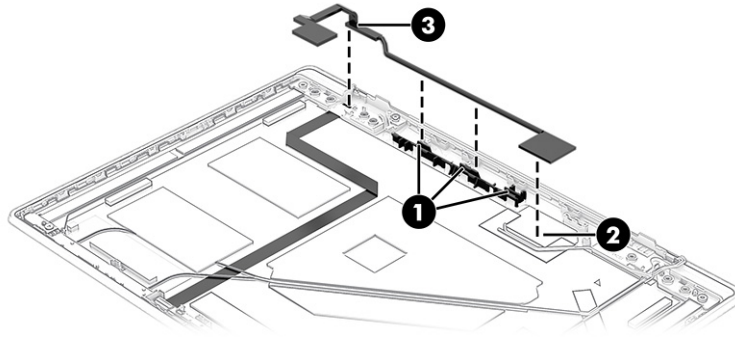

The display cables is available as the following spare part numbers:

N87096-001: Touch screen, WLAN only

N87097-001: Non-touch screen, WLAN only

N93426-001: Touch screen, WWAN only

N93427-001: Non-touch screen, WWAN only

10. To remove the WLAN antennas and cables, release the cables from the tape **(1)** on the display rear cover, and then peel the WLAN antennas **(2)** off the cover.

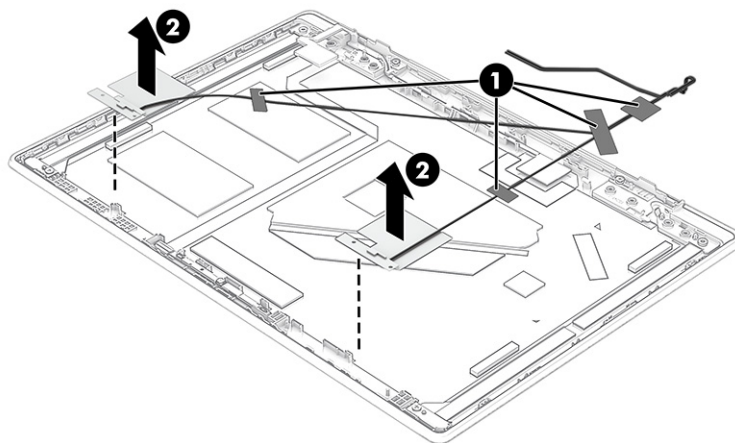

The WLAN wireless cables and antennas are available as spare part number N84554-001. The wireless cables and antennas are also included in the display rear cover spare part kit.

11. To remove the WWAN antennas and cables, release the cables from the retention clips (1) built into the display back cover, and then peel the antennas (2) off the cover.

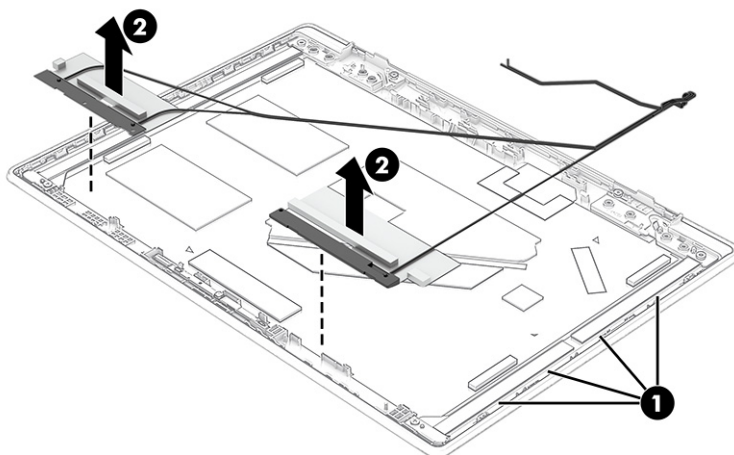

The WWAN cables and antennas are available as spare part number N84555-001. The wireless cables and antennas are also included in the display rear cover spare part kit.

To reassemble and replace the display assembly, reverse these procedures.

 **NOTE:** When installing the tape onto the display rear cover, be sure that the end of the tape is visible and accessible, and extends out slightly from under the installed display panel.

Lock bracket

To remove the lock bracket, use these procedures and illustrations.

Table 6-9 Lock bracket descriptions and part numbers

Description	Spare part number
Lock bracket, WWAN models (available in the Bracket Kit)	N87094-001
Lock bracket, non-WWAN models (available in the Bracket Kit)	N84559-001

Before removing the lock bracket, follow these steps:

1. Prepare the computer for disassembly ([Preparation for disassembly on page 28](#)).
2. Remove the bottom cover (see [Bottom cover on page 37](#)).
3. Disconnect the battery cable from the system board.
4. Remove the display assembly (see [Display assembly on page 53](#)).

Remove the lock bracket:

- After removing the display assembly, you can pull the lock bracket straight up and off the computer.

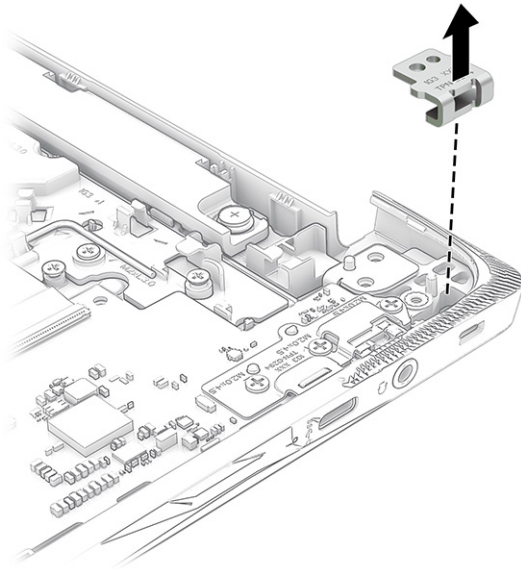

To install the lock bracket, reverse this procedure.

Top cover with keyboard

The top cover with keyboard remains after removing all other spare parts from the computer. The first table provides the main spare part number for the top covers with keyboards. The second table provides the keyboard country codes.

Table 6-10 Top cover with keyboard descriptions and part numbers

Description	Spare part number
Top cover with keyboard, models with WWAN	N83273-001
Top cover with keyboard, models without WWAN	N83274-001

Table 6-11 Spare part country codes

For use in country or region	Spare part number	For use in country or region	Spare part number	For use in country or region	Spare part number
Belgium	-A41	Hungary	-211	Saudi Arabia	-171
Brazil	-201	Iceland	-DD1	Slovenia	-BA1
Bulgaria	-261	India	-D61	South Korea	-AD1
Chile	-161	Israel	-BB1	Spain	-071
Czech Republic/Slovakia	-FL1	Italy	-061	Switzerland	-BG1
Denmark	-081	Japan	-291	Taiwan	-AB1
Denmark, Finland, and Norway	-DH1	The Netherlands	-B31	Thailand	-281
French Canada	-DB1	Northern Africa	-FP1	Turkey	-141

Table 6-11 Spare part country codes (continued)

For use in country or region	Spare part number	For use in country or region	Spare part number	For use in country or region	Spare part number
Finland/Sweden	-B71	Norway	-091	Turkey-F	-541
France	-051	Portugal	-131	Ukraine	-BD1
Germany	-041	Romania	-271	United Kingdom	-031
Greece	-151	Russia	-251	United States	-001

7 Backing up, resetting, and recovering

This chapter provides information about the standard procedures of backing up your personal data, resetting your computer to original factory conditions, and recovering your operating system.

Backing up

You can back up your data to an optional USB flash drive or SD memory card or through Google Drive™.

For detailed information about creating a backup, go to <http://www.support.google.com>.

Resetting

A factory reset erases the information on your computer hard drive, including files in the Downloads folder. Before you reset, back up your files to an optional USB flash drive, to an SD memory card, or through Google Drive. The factory reset will not delete your files at these locations.

You might want to reset your computer in the following circumstances:

- You see the message "Reset this Chrome device."
- You are having problems with your user profile or settings.
- You restarted your computer, and it still doesn't work properly.
- You want to change the owner of your computer.

To reset your computer:

1. Under the **Settings** menu, select **Advanced**.
2. In the **Powerwash** section, select **Powerwash**.
3. Select **Restart**.
4. In the window that appears, select **Powerwash**, and then select **Continue**.
5. Follow the on-screen instructions to reset your computer, and sign in with your Google Account.

 **NOTE:** The account you sign in with after you reset your computer is recognized as the owner account.

6. After you complete the reset, you can set up your computer and check to see whether the problem is fixed.

Recovering

When your ChromeOS™ doesn't work properly, you can perform a recovery. A recovery reinstalls the operating system, software programs, and original factory settings. It deletes locally saved files and

saved networks for all accounts. A system recovery does not affect Google Accounts and data synced to Google Drive.

 **IMPORTANT:** Recovery permanently erases everything on your computer hard drive, including your downloaded files. If possible, back up your files before you recover your computer.

 **NOTE:** For more information about performing a system recovery on your computer, go to <http://www.support.google.com>.

Before you begin the recovery process, you need the following prerequisites:

- A USB flash drive or SD memory card with a capacity of 4 GB or greater. All data is erased from this storage device when the recovery media is created, so back up all files from the device before you begin.
- A computer with internet access. You must also have administrative rights to the computer.
- A computer AC adapter. The computer must be plugged into AC power during recovery.
- The “ChromeOS is missing or damaged” screen displaying on your computer. If this message is not already displayed:
 - Turn on the computer, press and hold the **esc+f3** keys, and then press the power button. The computer restarts, and the screen shows the “ChromeOS is missing or damaged” screen.

Option 1: Recovering using an internet connection

Use these instructions to recover the Chrome operating system on your computer without recovery media:

1. Disconnect any external devices connected to your computer, plug in the power cord, and then turn on the computer.
2. To enter recovery mode, press and hold the **esc+f3** keys, and then press the power button. When the “ChromeOS is missing or damaged” screen appears, select **Recover using internet connection** and follow the on-screen instructions.

 **NOTE:** The computer must have internet access.

3. When the “System Recovery is complete” message appears, reboot your computer.

The computer restarts with ChromeOS reinstalled.

Option 2: Installing the Chromebook Recovery Utility

The Chromebook™ Recovery Utility recovers the original operating system and software programs that were installed at the factory. You can install this utility from the Chrome Web Store on any computer.

 **NOTE:** Use this option if you do not have Internet access on your computer.

To install the Chromebook Recovery Utility:

- Open the Chrome Web Store, search for `chrome recovery`, select **Chromebook Recovery Utility** from the Apps list, and follow the on-screen instructions.

Creating recovery media

You can use recovery media to recover the original operating system and software programs that were installed at the factory.

To create recovery media:

1. Turn on a computer that has internet access.



NOTE: You must have administrative rights to the computer.

2. Select the **Launcher** icon, and then select **All Apps**.
3. In the Apps window, select **Recovery**, and then select **Get started**.
4. Follow the on-screen instructions to create the recovery media.



NOTE: All data and partitions on your recovery media will be deleted. Do not remove the USB flash drive or SD memory card until the process is complete.

Recovering the Chrome operating system with recovery media

Use these instructions to recover the Chrome operating system on your computer using the recovery media that you created.

1. Disconnect any external devices connected to your computer, plug in the power cord, and then turn on the computer.
2. To enter recovery mode, press and hold **esc+f3**, and then press the power button. When the “ChromeOS is missing or damaged” screen appears, insert the recovery media into your computer. The recovery process begins immediately.
3. Wait while Chrome verifies the integrity of the recovery media.



NOTE: If you need to cancel the recovery during the verification process, press and hold the power button until the computer turns off. Do not disrupt the system recovery process after the verification step is complete.



NOTE: If an error message is displayed, you might need to run the Chrome Recovery Utility again or use a different USB flash drive or SD memory card.

4. When the “System Recovery is complete” message appears, remove the recovery media.

The computer restarts with ChromeOS reinstalled.

Setting up your computer after a reset or recovery

After a reset or recovery is complete, perform the initial setup process.

For details about setting up the computer, go to <http://www.support.google.com>.

Erasing and reformatting the recovery media

When you create recovery media, the USB flash drive or SD memory card is formatted as a recovery tool. After recovery, you must erase the recovery media to reuse your storage device. Follow these steps to use the Chromebook Recovery Utility to erase the recovery media.

1. Select the **Launcher** icon, and then select **All Apps**.
2. In the apps window, select **Recovery**.
3. Select the **Settings** icon, and then select **Erase recovery media**.
4. Select the USB flash drive or SD memory card that you inserted, select **Continue**, and then select **Erase now**.
5. After the recovery media is erased, select **Done** to close the Chromebook Recovery Utility, and then remove the USB flash drive or SD memory card.

The media is ready to be formatted using a formatting tool provided by your operating system.

8 Statement of memory volatility

For general information regarding nonvolatile memory in HP business computers, and to restore nonvolatile memory that can contain personal data after the system has been turned off and the hard drive has been removed, use these instructions.

HP business computer products that use Intel®-based or AMD®-based system boards contain volatile DDR memory. The amount of nonvolatile memory present in the system depends upon the system configuration. Intel-based and AMD-based system boards contain nonvolatile memory subcomponents as originally shipped from HP, with the following assumptions:

- No subsequent modifications were made to the system.
- No applications, features, or functionality were added to or installed on the system.

Following system shutdown and removal of all power sources from an HP business computer system, personal data can remain on volatile system memory (DIMMs) for a finite period of time and also remains in nonvolatile memory. Use the following steps to remove personal data from the computer, including the nonvolatile memory found in Intel-based and AMD-based system boards.

 **NOTE:** If your tablet has a keyboard base, connect to the keyboard base before beginning steps in this chapter.

Current BIOS steps

Use these instructions to restore nonvolatile memory.

1. Follow these steps to restore the nonvolatile memory that can contain personal data. Restoring or reprogramming nonvolatile memory that does not store personal data is neither necessary nor recommended.

- a. Turn on or restart the computer, and then quickly press **esc**.

 **NOTE:** If the system has a BIOS administrator password, type the password at the prompt.

- b. Select **Main**, select **Apply Factory Defaults and Exit**, and then select **Yes** to load defaults. The computer restarts.
- c. During the restart, press **esc** while the "Press the ESC key for Startup Menu" message is displayed at the bottom of the screen.

 **NOTE:** If the system has a BIOS administrator password, type the password at the prompt.

- d. Select the **Security** menu, select **Restore Security Settings to Factory Defaults**, and then select **Yes** to restore security level defaults. The computer restarts.
- e. During the restart, press **esc** while the "Press the ESC key for Startup Menu" message is displayed at the bottom of the screen.

 **NOTE:** If the system has a BIOS administrator password, type the password at the prompt.

- f. If an asset or ownership tag is set, select the **Security** menu and scroll down to the **Utilities** menu. Select **System IDs**, and then select **Asset Tracking Number**. Clear the tag, and then make the selection to return to the prior menu.
- g. If a DriveLock password is set, select the **Security** menu, and scroll down to **Hard Drive Utilities** under the **Utilities** menu. Select **Hard Drive Utilities**, select **DriveLock**, and then clear the check box for **DriveLock password on restart**. Select **OK** to proceed.
- h. Select the **Main** menu, and then select **Reset BIOS Security to factory default**. Select **Yes** at the warning message. The computer restarts.
- i. During the restart, press **esc** while the "Press the ESC key for Startup Menu" message is displayed at the bottom of the screen.



NOTE: If the system has a BIOS administrator password, type the password at the prompt.

- j. Select the **Main** menu, select **Apply Factory Defaults and Exit**, select **Yes** to save changes and exit, and then select **Shutdown**.
 - k. Restart the system. If the system has a Trusted Platform Module (TPM), fingerprint reader, or both, one or two prompts will appear—one to clear the TPM and the other to Reset Fingerprint Sensor. Press or tap **f1** to accept or **f2** to reject.
 - l. Remove all power and system batteries for at least 24 hours.
2. Complete one of the following tasks:
- Remove and retain the storage drive.
 - Clear the drive contents by using a third-party utility designed to erase data from an SSD.
 - Clear the contents of the drive by using the following BIOS Setup Secure Erase command option steps:



NOTE: If you clear data using Secure Erase, you cannot recover it.

- a. Turn on or restart the computer, and then quickly press **esc**.
- b. Select the **Security** menu and scroll down to the **esc** menu.
- c. Select **Hard Drive Utilities**.
- d. Finish by completing one of these tasks:
 - Under **Utilities**, select **Secure Erase**, select the hard drive storing the data you want to clear, and then follow the on-screen instructions to continue.
 - Clear the contents of the drive using the following Disk Sanitizer commands steps:
 - i. Turn on or restart the computer, and then quickly press **esc**.
 - ii. Select the **Security** menu and scroll down to the **Utilities** menu.
 - iii. Select **Hard Drive Utilities**.

- iv. Under **Utilities**, select **Disk Sanitizer**, select the hard drive with the data that you want to clear, and then follow the on-screen instructions to continue.

 **NOTE:** The amount of time it takes for Disk Sanitizer to run can take several hours. Plug the computer into an AC outlet before starting.

Nonvolatile memory usage

Use this table to troubleshoot nonvolatile memory usage.

Table 8-1 Troubleshooting information for nonvolatile memory usage

Description	Volatility description	Storage user data	How to erase
Primary storage device, holds the OS, applications, and application settings	Nonvolatile, 8-256 GB of eMMC or NVMe SSD storage, removable	Yes ¹	Follow instructions below under "Erase the Primary Storage Device."
System memory (RAM), holds transient data during system operation	Volatile, SODIMM socket. Removable (4 GB/8 GB/16 GB)	Yes	Unplug unit from power.
Permanent system BIOS settings	Nonvolatile; 16 KB; stored	No ²	Follow instructions below under "Clearing BIOS Settings."
System boot ROM (BIOS)	Nonvolatile memory, 128 Mbit (16 MB) socketed, removable	No	Download the latest BIOS for your model from the HP website and follow the instructions to flash the BIOS that are on the website.
RTC (CMOS) RAM	Volatile memory, 256 bytes located in AMD embedded System on Chip (SoC)	No	<p>Desktop computers with a CMOS button:</p> <p>Unplug unit from main power, remove top cover and press the Clear CMOS button.</p> <p>Notebook and desktop computers without a CMOS button:</p> <ol style="list-style-type: none"> 1. Press and hold power button for 12 seconds. 2. Press Windows key + V, and then press power button.
Keyboard/mouse (ROM)	Nonvolatile, 2 KB embedded in the super I/O controller (SIO2)	Yes	N/A
Keyboard/mouse (RAM)	Volatile, 256 bytes embedded in the super I/O controller (SIO2)	No	Unplug unit from main power.
LOM EEPROM	Nonvolatile, 2 MB embedded in LAN controller	No	N/A
Trusted Platform Module (TPM)	Nonvolatile; 51 KB ROM for firmware and 38 KB system parametric data	No ³	Follow instructions below under "Clearing TPM."

¹ Under typical operation, the only user data stored on the primary storage device are preferences for device configuration and settings for connections. However, the administrator can configure the system to allow users to store data locally.

² The only user data potentially stored in BIOS Settings are the ownership and asset tags, administrator password, and startup password.

³ The Trusted Platform Module might contain encrypted passwords or certificates generated from user or administrator input.

Questions and answers

Use this section to answer your questions about nonvolatile memory.

1. How can the BIOS settings be restored (returned to factory settings)?

 **IMPORTANT:** The restore defaults feature does not securely erase any information on your hard drive. See question and answer 6 for steps to securely erase information.

The restore defaults feature does not reset the Custom Secure Boot keys. See question and answer 7 for information about resetting the keys.

- a. Turn on or restart the computer, and then quickly press **esc**.
- b. Select **Main**, and then select **Apply Factory Defaults and Exit**.
- c. Follow the on-screen instructions.
- d. Select **Main**, select **Save Changes and Exit**, and then follow the on-screen instructions.

2. What is a UEFI BIOS?

The Unified Extensible Firmware Interface (UEFI) BIOS is an industry-standard software interface between the platform firmware and an operating system (OS). It replaces the older BIOS architecture but supports much of the legacy BIOS functionality.

Like the legacy BIOS, the UEFI BIOS provides an interface to display the system information and configuration settings and to change the configuration of your computer before an OS is loaded. BIOS provides a secure runtime environment that supports a GUI. In this environment, you can use either a pointing device (touch screen, touchpad, pointing stick, or USB mouse) or the keyboard to navigate and make menu and configuration selections. The UEFI BIOS also contains basic system diagnostics.

The UEFI BIOS provides functionality beyond that of the legacy BIOS. In addition, the UEFI BIOS works to initialize the computer's hardware before loading and executing the OS; the runtime environment allows the loading and execution of software programs from storage devices to provide more functionality, such as advanced hardware diagnostics (with the ability to display more detailed system information) and advanced firmware management and recovery software.

3. Where is the UEFI BIOS located?

The UEFI BIOS is located on a flash memory chip. You must use a utility to write to the chip.

4. What kind of configuration data is stored on the DIMM Serial Presence Detect (SPD) memory module? How would this data be written?

The DIMM SPD memory contains information about the memory module, such as size, serial number, data width, speed and timing, voltage, and thermal information. This information is written by the module manufacturer and stored on an EEPROM. You cannot write to this EEPROM when the memory module is installed in a computer. Third-party tools do exist that can write to the EEPROM when the memory module is not installed in a computer. Various third-party tools are available to read SPD memory.

5. What is meant by “Restore the nonvolatile memory found in Intel-based system boards”?

This message relates to clearing the Real Time Clock (RTC) CMOS memory that contains computer configuration data.

6. How can the BIOS security be reset to factory defaults and erase the data?

 **IMPORTANT:** Resetting results in the loss of information.

These steps do not reset Custom Secure Boot Keys. See question and answer 7 for information about resetting the keys.

- a. Turn on or restart the computer, and then quickly press **esc**.
- b. Select **Main**, and then select **Reset Security to Factory Defaults**.
- c. Follow the on-screen instructions.
- d. Select **Main**, select **Save Changes and Exit**, and then follow the on-screen instructions.

7. How can the Custom Secure Boot Keys be reset?

Secure Boot is a feature to ensure that only authenticated code can start on a platform. If you enabled Secure Boot and created Custom Secure Boot Keys, disabling Secure Boot does not clear the keys. You must also select to clear the Custom Secure Boot Keys. Use the same Secure Boot access procedure that you used to create the Custom Secure Boot Keys, but select to clear or delete all Secure Boot Keys.

- a. Turn on or restart the computer, and then quickly press **esc**.
- b. Select the **Security** menu, select **Secure Boot Configuration**, and then follow the on-screen instructions.
- c. At the **Secure Boot Configuration** window, select **Secure Boot**, select **Clear Secure Boot Keys**, and then follow the on-screen instructions to continue.

Using HP Sure Start (select products only)

Select computer models are configured with HP Sure Start, a technology that monitors the computer's BIOS for attacks or corruption. If the BIOS becomes corrupted or is attacked, HP Sure Start automatically restores the BIOS to its previously safe state, without user intervention.

HP Sure Start is configured and already enabled so that most users can use the HP Sure Start default configuration. Advanced users can customize the default configuration.

To access the latest documentation on HP Sure Start, go to <http://www.hp.com/support>. Select **Find your product**, and then follow the on-screen instructions.

9 Specifications

This chapter provides specifications for your computer system.

Computer specifications

This section provides specifications for your computer. When you travel with your computer, the computer dimensions and weights, as well as input power ratings and operating specifications, provide helpful information.

Table 9-1 Computer specifications

	Metric	U.S.
Dimensions		
Width	330.5 mm	13.0 in
Depth	230.5 mm	9.1 in
Height (front)	7.1 mm	0.3 in
Weight		
	1.6 kg	3.6 lb
Input power		
Operating voltage and current	5 V DC @ 2 A / 12 V DC @ 3 A / 15 V DC @ 3 A - 45 W USB-C	
	5 V DC @ 3 A / 9 V DC @ 3 A / 12 V DC @ 3.75 A / 15 V DC @ 3 A - 45 W USB-C	
	5 V DC @ 3 A / 9 V DC @ 3 A / 10 V DC @ 3.75 A / 12 V DC @ 3.75 A / 15 V DC @ 3 A / 20 V DC @ 2.25 A - 45 W USB-C	
	5 V DC @ 3 A / 9 V DC @ 3 A / 12 V DC @ 5 A / 15 V DC @ 4.33 A / 20 V DC @ 3.25 A - 65 W USB-C	
	5 V DC @ 3 A / 9 V DC @ 3 A / 10 V DC @ 5 A / 12 V DC @ 5 A / 15 V DC @ 4.33 A / 20 V DC @ 3.25 A - 65 W USB-C	
Temperature		
Operating	5°C to 35°C	41°F to 95°F
Nonoperating	-20°C to 60°C	-4°F to 140°F
Relative humidity (noncondensing)		
Operating	10% to 90%	
Nonoperating	5% to 95%	
Maximum altitude (unpressurized)		
Operating	-15 m to 3,048 m	-50 ft to 10,000 ft

Table 9-1 Computer specifications (continued)

	Metric	U.S.
Nonoperating	-15 m to 12,192 m	-50 ft to 40,000 ft



NOTE: Applicable product safety standards specify thermal limits for plastic surfaces. The device operates well within this range of temperatures.

35.6 cm (14.0 in) display specifications

This section provides specifications for your display.

Table 9-2 Display specifications

	Metric	U.S.
Active diagonal size	35.6 cm	14 in
Resolution	1920 × 1080 (FHD) 1366 × 768 (HD)	
Surface treatment	Antiglare (FHD, UHD panels) Brightview (OLED panel)	
Brightness	300 nits 250 nits	
Viewing angle	UWVA	
Backlight	WLED	
Display panel interface	eDP	

10 Power cord set requirements

This chapter provides power cord requirements for countries and regions.

The wide-range input feature of the computer permits it to operate from any line voltage from 100 V AC to 120 V AC, or from 220 V AC to 240 V AC.

The three-conductor power cord set included with the computer meets the requirements for use in the country or region where the equipment is purchased.

Power cord sets for use in other countries or regions must meet the requirements of the country and region where the computer is used.

Requirements for all countries

These power cord requirements are applicable to all countries and regions.

- The length of the power cord set must be at least **1.0 m** (3.3 ft) and no more than **2.0 m** (6.5 ft).
- All power cord sets must be approved by an acceptable accredited agency responsible for evaluation in the country or region where the power cord set will be used.
- The power cord sets must have a minimum current capacity of 10 A and a nominal voltage rating of 125 V AC or 250 V AC, as required by the power system of each country or region.
- The appliance coupler must meet the mechanical configuration of an EN 60 320/IEC 320 Standard Sheet C13 connector for mating with the appliance inlet on the back of the computer.

Requirements for specific countries and regions

To determine power cord requirements for specific countries and regions, use this table.

Table 10-1 Power cord requirements for specific countries and regions

Country/region	Accredited agency	Applicable note number
Argentina	IRAM	1
Australia	SAA	1
Austria	OVE	1
Belgium	CEBEC	1
Brazil	ABNT	1
Canada	CSA	2
Chile	IMQ	1
Denmark	DEMKO	1
Finland	FIMKO	1
France	UTE	1

Table 10-1 Power cord requirements for specific countries and regions (continued)

Country/region	Accredited agency	Applicable note number
Germany	VDE	1
India	BIS	1
Israel	SII	1
Italy	IMQ	1
Japan	JIS	3
Netherlands	KEMA	1
New Zealand	SANZ	1
Norway	NEMKO	1
People's Republic of China	CCC	4
Saudi Arabia	SASO	7
Singapore	PSB	1
South Africa	SABS	1
South Korea	KTL	5
Sweden	SEMKO	1
Switzerland	SEV	1
Taiwan	BSMI	6
Thailand	TISI	1
United Kingdom	ASTA	1
United States	UL	2

1. The flexible cord must be Type HO5VV-F, three-conductor, 0.75 mm² conductor size. Power cord set fittings (appliance coupler and wall plug) must bear the certification mark of the agency responsible for evaluation in the country or region where it will be used.
2. The flexible cord must be Type SVT/SJT or equivalent, No. 18 AWG, three-conductor. The wall plug must be a two-pole grounding type with a NEMA 5-15P (15 A, 125 V AC) or NEMA 6-15P (15 A, 250 V AC) configuration. CSA or C-UL mark. UL file number must be on each element.
3. The appliance coupler, flexible cord, and wall plug must bear a T mark and registration number in accordance with the Japanese Dentori Law. The flexible cord must be Type VCTF, three-conductor, 0.75 mm² or 1.25 mm² conductor size. The wall plug must be a two-pole grounding type with a Japanese Industrial Standard C8303 (7 A, 125 V AC) configuration.
4. The flexible cord must be Type RVV, three-conductor, 0.75 mm² conductor size. Power cord set fittings (appliance coupler and wall plug) must bear the CCC certification mark.
5. The flexible cord must be Type H05VV-F three-conductor, 0.75 mm² conductor size. KTL logo and individual approval number must be on each element. Approval number and logo must be printed on a flag label.
6. The flexible cord must be Type HVCTF three-conductor, 1.25 mm² conductor size. Power cord set fittings (appliance coupler, cable, and wall plug) must bear the BSMI certification mark.

7. For 127 V AC, the flexible cord must be Type SVT or SJT 3-conductor, 18 AWG, with plug NEMA 5-15P (15 A, 125 V AC), with UL and CSA or C-UL marks. For 240 V AC, the flexible cord must be Type H05VV-F three-conductor, 0.75 mm² or 1.00 mm² conductor size, with plug BS 1363/A with BSI or ASTA marks.

11 Swelling or deformation of notebook battery

To protect your hardware from potential damage, HP recommends that if you are experiencing battery swelling, stop using the notebook until you can replace the battery.

You can contact HP to understand what battery replacement options are available. To learn more about Lithium-ion batteries and the factors that can accelerate battery swelling, see https://support.hp.com/us-en/document/ish_6824662-6824706-16.

Swollen notebook batteries

You might notice that your notebook battery has become somewhat deformed or swollen over time. In some cases, the battery swelling might be significant enough to impact other components of the system including the touchpad, keyboard, and chassis.

Swollen battery is not a safety issue

A swollen battery does not present a safety issue. It is the result of the generation of gases per the normal degradation of the battery cell over time.

HP has worked closely with our battery cell suppliers and third-party industry experts to help minimize the potential for HP batteries to swell over time and to identify that swollen batteries are not a safety issue.

Discontinue using a swollen battery

To protect your hardware from potential damage, HP recommends that, if you are experiencing battery swelling, you stop using the notebook until the battery can be replaced.

You can contact <https://www.hp.com/go/contacthp> to understand what battery replacement options are available.

Replace a swollen battery

If a battery is under warranty, HP will replace the battery per the terms and conditions of the HP Worldwide Limited Warranty or applicable HP Care Packs.

For batteries no longer under warranty, contact HP to purchase a genuine HP replacement battery.

Minimize battery swelling

Multiple factors can accelerate battery swelling.

To help mitigate battery swelling over time, you can use either HP Adaptive Battery Optimizer (consumer notebooks) or HP Battery Health Manager (commercial notebooks) settings to improve battery longevity and performance for various use scenarios.

HP Adaptive Battery Optimizer (consumer notebooks)

HP Adaptive Battery Optimizer technology can help mitigate the factors that cause the battery to swell. It is available on select HP OMEN, HP Spectre, HP Pavilion, and HP ENVY notebook computers.

HP Adaptive Battery Optimizer has been available on select gaming notebooks since 2019 and select consumer notebooks since 2020. To learn more about enabling HP Adaptive Battery Optimizer on your HP notebook, see <https://support.hp.com/us-en/document/c06310986>.

HP Battery Health Manager (commercial notebooks)

HP Battery Health Manager provides an easy-to-manage solution to help mitigate factors that cause the battery to swell. It is available on select HP ProBook and HP EliteBook notebook computers.

HP Battery Health Manager is available on select commercial notebooks manufactured since 2016. To learn more about HP Battery Health Manager, see https://support.hp.com/us-en/document/ish_4449597-3519507-16.

12 Recycling

When a nonrechargeable or rechargeable battery has reached the end of its useful life, do not dispose of the battery in general household waste. Follow the local laws and regulations in your area for battery disposal.

HP encourages customers to recycle used electronic hardware, HP original print cartridges, and rechargeable batteries. For more information about recycling programs, see the HP website at <http://www.hp.com/recycle>.

Index

- A**
 - AC adapter light 3, 5
 - AC adapter, spare part numbers 15
 - action keys
 - identifying 7
 - audio-in (microphone) jack, identifying 4
 - audio-out (headphone) jack, identifying 4
 - audio, product description 1
- B**
 - backing up 63
 - battery
 - illustrated 12
 - light 3, 5
 - removal and replacement 29
 - spare part number 12
 - spare part numbers 29
 - battery swelling 77
 - Bluetooth label 9
 - bottom cover
 - illustrated 12
 - removal 37
 - spare part number 12, 37
 - bracket kit
 - components 14
- C**
 - camera 5
 - identifying 5
 - illustrated 14
 - spare part numbers 14
 - camera cable
 - illustrated 14
 - spare part number 14
 - camera light, identifying 6
 - camera privacy cover, identifying 6
 - caring for your computer 23
 - cautions
 - electrostatic discharge 19, 20
 - Chromebook major components 11
 - Chromebook Recovery Utility, installing 64
 - cleaning your computer 23
 - caring for wood veneer 25
 - disinfecting 24
 - HP Easy Clean 23
 - removing dirt and debris 23
 - components
 - bottom 8
 - display 5
 - keyboard area 6
 - left side 4
 - right side 3
 - computer specifications 72
 - connector, power 3, 4
- D**
 - display
 - specifications 72, 73
 - display assembly
 - illustrated 12
 - subcomponents 13
 - display back cover
 - illustrated 14
 - spare part number 14
 - display bezel
 - illustrated 13
 - spare part numbers 13
 - display panel
 - illustrated 13
 - spare part numbers 13
- E**
 - electrostatic discharge (ESD) 19, 20
 - preventing damage 19-21
 - esc key, identifying 7
- G**
 - graphics, product description 1
 - grounding methods 19-21
 - guidelines
 - packaging 19, 25
 - transporting 19, 25
 - workstation 19
- H**
 - hard drive
 - product description 1
 - specifications 72
 - HDMI port, identifying 4
 - headphone (audio-out) jack 4
 - heat sink
 - illustrated 12
 - removal 50
 - spare part number 12, 50
 - hinge
 - illustrated 14
 - spare part number 14
 - HP Sure Start 67
- I**
 - illustrated parts catalog 11
 - internal microphones, identifying 5
- J**
 - jacks
 - audio-in (microphone) 4
 - audio-out (headphone) 4
- K**
 - keyboard
 - product description 2
 - keyboard country codes 61
 - keys
 - esc 7
 - power 8
- L**
 - labels
 - Bluetooth 9
 - regulatory 9
 - serial number 9
 - service 9
 - wireless certification 9
 - WLAN 9
 - lights
 - AC adapter and battery 3, 5
 - camera 6
 - lock bracket
 - removal 60
 - spare part number 60

M

- memory
 - nonvolatile 67
 - volatile 67
- memory module
 - product description 1
- microphone
 - product description 1
- microphone (audio-in) jack,
 - identifying 4
- model name 1

N

- nonvolatile memory 67

O

- operating system, product
 - description 2

P

- packaging guidelines 19, 25
- pointing device, product
 - description 2
- ports
 - HDMI 4
 - product description 2
 - USB SuperSpeed 3
 - USB Type-C power connector
 - and port with HP Sleep and Charge 3, 4
- power connector
 - identifying USB Type-C 3, 4
- power cord
 - requirements for all
 - countries 74
 - requirements for specific
 - countries and regions 74
 - set requirements 74
 - spare part numbers 16
- power key, identifying 8
- power requirements, product
 - description 2
- primary storage
 - product description 1
- processor
 - product description 1
- product description
 - audio 1
 - graphics 1
 - hard drive 1
 - keyboard 2
 - memory module 1
 - microphone 1

- operating system 2
- pointing device 2
- ports 2
- power requirements 2
- primary storage 1
- processors 1
- product name 1
- serviceability 2
- solid-state drive 1
- video 1
- wireless 1

- product name 1
- product name and number,
 - computer 9

R

- recovery media
 - creating 65
 - erase 66
- recovery, performing 63
- regulatory information
 - regulatory label 9
 - wireless certification labels 9
- removal
 - speaker 42
- removal and replacement
 - battery 29
 - procedures 28, 37
 - touchpad 48
- removing personal data from
 - volatile system memory 67
- resetting 63

S

- security cable slot, identifying 4
- serial number, computer 9
- service labels, locating 9
- serviceability, product
 - description 2
- slots
 - security cable 4
- solid-state drive
 - product description 1
- spare part numbers
 - battery 29
 - bracket kit components 14
 - camera 14
 - camera cable 14
 - display assembly
 - components 13
 - display back cover 14
 - display bezel 13
 - display panel 13
 - hinges 14

- speaker 42
- touchpad 48

- speaker
 - illustrated 12
 - removal 42
 - spare part number 12
 - spare part numbers 42
- speakers, identifying 7
- specifications
 - computer 72
 - display 72, 73
 - hard drive 72
- static electricity 19, 20
- support information 25
- Sure Start
 - using 71
- swelling or deformation of
 - notebook battery 77
- system board
 - illustrated 12
 - removal 51
 - spare part numbers 12, 51
- system memory, removing
 - personal data from volatile 67
- system recovery
 - Chrome operating system 65
 - Chromebook Recovery
 - Utility 64
 - internet connection 64
 - recovery media 65

T

- top cover
 - illustrated 12
 - spare part number 12
- top cover with keyboard
 - spare part numbers 61
- touchpad
 - illustrated 12
 - removal and replacement 48
 - spare part number 12
 - spare part numbers 48
- touchpad zone, identifying 6
- transporting guidelines 19, 25
- traveling with the computer 9

U

- USB board
 - illustrated 12
 - removal 45
 - spare part number 12, 45
- USB ports, identifying 3

USB Type-C power connector and port with HP Sleep and Charge, identifying 3, 4

V

video, product description 1

W

wireless certification label 9

wireless, product description 1

WLAN antennas, identifying 5, 8

WLAN device 9

WLAN label 9

WLAN module

illustrated 12

removal 46

spare part number 12, 46

workstation guidelines 19

WWAN module

illustrated 12

removal 43

spare part number 12

spare part numbers 43