



# Maintenance and Service Guide

## HP Elite x360 14 inch G11 Notebook PC

### **SUMMARY**

This guide provides maintenance information about such topics as spare parts, removal and replacement of parts, security, and backing up.

# Legal information

© Copyright 2024 HP Development Company, L.P.

AMD is a trademark of Advanced Micro Devices, Inc. Bluetooth is a trademark owned by its proprietor and used by HP Inc. under license. Chrome and Google are trademarks of Google LLC. Intel, Core, and Thunderbolt are trademarks of Intel Corporation or its subsidiaries in the U.S. and/or other countries. Microsoft and Windows are either registered trademarks or trademarks of Microsoft Corporation in the United States and/or other countries. USB Type-C is registered trademark of USB Implementers Forum. DisplayPort™ and the DisplayPort™ logo are trademarks owned by the Video Electronics Standards Association (VESA) in the United States and other countries. Wi-Fi is a registered trademark of Wi-Fi Alliance.

The information contained herein is subject to change without notice. The only warranties for HP products and services are set forth in the express warranty statements accompanying such products and services. Nothing herein should be construed as constituting an additional warranty. HP shall not be liable for technical or editorial errors or omissions contained herein.

Second Edition: October 2024

First Edition: May 2024

Document Part Number: N99986-002

## Product notice

This guide describes features that are common to most models. Some features may not be available on your computer.

Not all features are available in all editions or versions of Windows. Systems may require upgraded and/or separately purchased hardware, drivers, software or BIOS update to take full advantage of Windows functionality. Windows is automatically updated, which is always enabled. High-speed internet and Microsoft account required. ISP fees may apply and additional requirements may apply over time for updates. See <http://www.microsoft.com>.

**If your product ships with Windows in S Mode:** Windows in S Mode works exclusively with apps from the Microsoft Store within Windows. Certain default settings, features, and apps cannot be changed. Some accessories and apps that are compatible with Windows may not work (including some antivirus, PDF writers, driver utilities, and accessibility apps), and performance may vary, even if you switch out of S Mode. If you switch to Windows, you cannot switch back to S Mode. Learn more at [Windows.com/SmodeFAQ](http://Windows.com/SmodeFAQ).

To access the latest user guides, go to <http://www.hp.com/support>, and follow the instructions to find your product. Then select **Setup & User Guides**.

To help us improve this document, please send any suggestions, comments, or errors to <mailto:hp.doc.feedback@hp.com>. Include the document part number when submitting your feedback.

## Software terms

By installing, copying, downloading, or otherwise using any software product preinstalled on this computer, you agree to be bound by the terms of the HP End User License Agreement (EULA). If you do not accept these license terms, your sole remedy is to return the entire unused product (hardware and software) within 14 days for a full refund subject to the refund policy of your seller.

For any further information or to request a full refund of the price of the computer, please contact your seller.

## Safety warning notice

Reduce the possibility of heat-related injuries or of overheating the computer by following the practices described.

- 
-  **WARNING!** To reduce the possibility of heat-related injuries or of overheating the mobile computer, do not place the mobile computer directly on your lap or obstruct the computer air vents. Use the mobile computer only on a hard, flat surface. Do not allow another hard surface, such as an adjoining optional printer; or a soft surface, such as pillows or rugs or clothing, to block airflow. Also, do not allow the AC adapter to contact the skin or a soft surface, such as pillows or rugs or clothing, during operation. The computer and AC adapter provided by HP comply with the user-accessible surface temperature limits defined by applicable safety standards.
-

---

# Table of contents

<b>1 Product description</b>	<b>1</b>
<b>2 Components</b>	<b>5</b>
Locating hardware	5
Locating software	5
Right	5
Left	6
360 modes (select products only)	8
Display	9
Auto Lock and Awake	9
Low blue light mode (select products only)	9
Keyboard area	11
Touchpad	11
Touchpad settings	11
Adjusting touchpad settings	11
Turning on the touchpad	11
Touchpad components	11
Lights	12
Button, speakers, and fingerprint reader	14
Special keys	15
Bottom	16
Rear	17
Labels	18
Using a SIM card (select products only)	20
Determining the correct SIM card size for your computer	20
Inserting a nano SIM card	20
<b>3 Illustrated parts catalog</b>	<b>22</b>
Computer major components	22
Miscellaneous parts	28
<b>4 Removal and replacement procedures preliminary requirements</b>	<b>33</b>
Tools required	33
Service considerations	34

Plastic parts.....	34
Cables and connectors.....	34
Drive handling .....	34
Electrostatic discharge information.....	35
Generating static electricity.....	35
Preventing electrostatic damage to equipment.....	36
Personal grounding methods and equipment.....	36
Grounding the work area.....	36
Recommended materials and equipment.....	37
Cleaning your computer .....	38
Enabling HP Easy Clean (select products only).....	38
Removing dirt and debris from your computer.....	38
Cleaning your computer with a disinfectant.....	39
Caring for wood veneer (select products only).....	40
Packaging and transporting guidelines.....	40
Accessing support information .....	40
<b>5 Removal and replacement procedures for authorized service provider parts.....</b>	<b>43</b>
Component replacement procedures .....	44
Preparation for disassembly.....	44
Bottom cover .....	44
Battery.....	45
WWAN module.....	47
Solid-state drive.....	48
WLAN module.....	50
System board .....	51
Fan/heat sink assembly.....	56
Fingerprint reader cable.....	57
Fingerprint reader .....	58
Display assembly.....	59
Speakers.....	62
NFC module cable.....	63
NFC module .....	64
Touchpad cable.....	65
Touchpad .....	66
Transfer board cable .....	67
Transfer board.....	68
Top cover with keyboard.....	69
<b>6 Computer Setup (BIOS), TPM, and HP Sure Start .....</b>	<b>71</b>
Using Computer Setup .....	72
Navigating and selecting in Computer Setup .....	72
Restoring factory settings in Computer Setup.....	72
Updating the BIOS .....	73
Determining the BIOS version .....	73
Preparing for a BIOS update.....	73
Downloading a BIOS update.....	73
Installing a BIOS update .....	74

Changing the boot order using the f9 prompt .....	74
TPM BIOS settings (select products only) .....	75
Using HP Sure Start (select products only).....	75
<b>7 Backing up, restoring, and recovering.....</b>	<b>76</b>
Backing up information and creating recovery media .....	77
Using Windows tools for backing up.....	77
Using the HP Cloud Recovery Download Tool to create recovery media (select products only).....	77
Restoring and recovering your system.....	78
Creating a system restore .....	78
Restoring and recovery methods .....	78
Recovering using HP Recovery media.....	78
Changing the computer boot order .....	79
Using HP Sure Recover (select products only).....	79
<b>8 Using HP PC Hardware Diagnostics .....</b>	<b>80</b>
Using HP PC Hardware Diagnostics Windows (select products only).....	81
Using an HP PC Hardware Diagnostics Windows hardware failure ID code.....	81
Accessing HP PC Hardware Diagnostics Windows.....	81
Accessing HP PC Hardware Diagnostics Windows from HP Support Assistant.....	81
Accessing HP PC Hardware Diagnostics Windows from the Start menu (select products only).....	81
Downloading HP PC Hardware Diagnostics Windows.....	82
Downloading the latest HP PC Hardware Diagnostics Windows version from HP .....	82
Downloading the HP PC Hardware Diagnostics Windows from the Microsoft Store.....	82
Downloading HP Hardware Diagnostics Windows by product name or number (select products only) .....	82
Installing HP PC Hardware Diagnostics Windows.....	83
Using HP PC Hardware Diagnostics UEFI .....	84
Using an HP PC Hardware Diagnostics UEFI hardware failure ID code.....	84
Starting HP PC Hardware Diagnostics UEFI .....	84
Starting HP PC Hardware Diagnostics UEFI through HP Hotkey Support software (select products only).....	85
Downloading HP PC Hardware Diagnostics UEFI to a USB flash drive.....	85
Downloading the latest HP PC Hardware Diagnostics UEFI version .....	85
Downloading HP PC Hardware Diagnostics UEFI by product name or number (select products only) .....	86
Using Remote HP PC Hardware Diagnostics UEFI settings (select products only).....	87
Downloading Remote HP PC Hardware Diagnostics UEFI .....	87
Downloading the latest Remote HP PC Hardware Diagnostics UEFI version.....	87
Downloading Remote HP PC Hardware Diagnostics UEFI by product name or number .....	87
Customizing Remote HP PC Hardware Diagnostics UEFI settings.....	87
<b>9 Specifications.....</b>	<b>89</b>
Computer specifications .....	89
Display specifications.....	90
Solid-state drive specifications .....	90
<b>10 Statement of memory volatility.....</b>	<b>92</b>

Current BIOS steps .....	92
Nonvolatile memory usage .....	94
Questions and answers .....	95
Using HP Sure Start (select products only).....	96
<b>11 Power cord set requirements.....</b>	<b>97</b>
Requirements for all countries .....	97
Requirements for specific countries and regions.....	97
<b>12 Recycling .....</b>	<b>100</b>
<b>Index.....</b>	<b>101</b>

# 1 Product description

This table provides detailed product information.

**Table 1-1 Product components and their descriptions**

Category	Description
<b>Product Name</b>	HP Elite x360 14 inch G11 Notebook PC
<b>Processors</b>	Intel® Core™ Ultra7 165H vPro Enterprise 5.00 GHz processor (16 cores, 24 MB L3 cache, 28 W)
	Intel Core Ultra7 155H 4.80 GHz processor (16 cores, 24 MB L3 cache, 28 W)
	Intel Core Ultra5 135H vPro Enterprise 4.60 GHz processor (14 cores, 18 MB L3 cache, 28 W)
	Intel Core Ultra5 135U vPro Enterprise 4.40 GHz processor (16 cores, 24 MB L3 cache, 15 W)
	Intel Core Ultra5 125H 4.50 GHz processor (14 cores, 18 MB L3 cache, 28 W)
<b>Graphics</b>	Intel integrated Soldered-on-Circuit (SoC)  Unified memory architecture (UMA)
<b>Display</b>	<b>35.6 cm (14.0 in), narrow bezel, ultrawide viewing angle (UWVA)</b>
	2.8K (2880 × 1800), GorillaGlass7, brightview, organic light-emitting diode (OLED) + low blue light (LBL), Digital Cinema Initiatives (DCI)-P3 100, embedded DisplayPort™ (eDP) 1.4 + panel self refresh (PSR) 120 Hz, non-Touch On Panel (nTOP), bent display panel; typical brightness: 400 nits
	2.8K (2880 × 1800), non-GorillaGlass7, brightview, OLED + LBL, DCI-P3 100, eDP 1.4 + PSR 120 Hz, variable refresh rate (VRR), nTOP, bent display panel; typical brightness: 400 nits
	Liquid crystal display (LCD), widescreen ultra extended graphics array (WUXGA, 1920 × 1200), antiglare, LBL, standard red/green/blue (sRGB) 100, eDP 1.4 + PSR + I/O link (IOL), SureView5, TOP, bent display panel, typical brightness: 800 nits
	Liquid crystal display (LCD), widescreen ultra extended graphics array (WUXGA, 1920 × 1200), antiglare, LBL, standard red/green/blue (sRGB) 100, eDP 1.4 + PSR + I/O link (IOL), SureView5, nTOP, bent display panel, typical brightness: 800 nits
	LCD, WUXGA (1920 × 1200), antiglare, LED, sRGB 100, eDP 1.4 + PSR, ACS, TOP, bent display panel, typical brightness: 400 nits
	LCD, WUXGA (1920 × 1200), antiglare, WLED + LBL, sRGB 100, eDP 1.3 + PSR, G4 Privacy Plus filter, ambient light sensor (ALS) + ACS, TOP, bent display panel, typical brightness: 1000 nits
	LCD, WUXGA (1920 × 1200), antiglare, WLED + LBL, sRGB 100, eDP 1.4 + PSR2, low power (LP), ACS, nTOP, bent display panel, typical brightness: 400 nits
	LCD, WUXGA (1920 × 1200), antiglare, WLED + LBL, sRGB 100, eDP 1.4 + PSR, ALS + ACS, SureView5, TOP, bent display panel, typical brightness: 800 nits
	LCD, WUXGA (1920 × 1200), antiglare, WLED + LBL, sRGB 100, eDP 1.4 + PSR, ALS + ACS, SureView5, nTOP, bent display panel, typical brightness: 800 nits

**Table 1-1 Product components and their descriptions (continued)**

Category	Description
	LCD, WUXGA (1920 × 1200), antiglare, WLED + LBL, sRGB 100, eDP 1.3 + PSR, G4 Privacy Plus filter, nTOP, bent display panel, typical brightness: 1000 nits
	LCD, WUXGA (1920 × 1200), antiglare, WLED + LBL, sRGB 100, eDP 1.4 + PSR2, nTOP, bent display panel, typical brightness: 400 nits
<b>Memory</b>	Low-power double data rate (LPDDRx)-7500 support
	Supports 64 GB and 32 GB configurations
<b>Primary storage</b>	2280, Peripheral Component Interconnect Express (PCIe), Non-Volatile Memory Express (NVMe), solid-state drives (SSDs)
	For use in all countries and regions except the People's Republic of China
	<ul style="list-style-type: none"> <li>• 2 TB, 2280, PCIe-4×4, NVMe SSD with triple layer cell (TLC)</li> <li>• 1 TB, 2280, PCIe-4×4, NVMe SSD with TLC</li> <li>• 1 TB, 2280, PCIe, NVMe, value SSD</li> <li>• 512 GB, PCIe-4×4, NVMe SSD with TLC</li> <li>• 512 GB, 2280, PCIe-4×4, NVMe, self-encrypted (SED) SSD with TLC and OPAL2</li> <li>• 256 GB, 2280, PCIe, NVMe, value SSD</li> <li>• 256 GB, 2280, PCIe, NVMe, value, SED SSD with TLC and OPAL2</li> </ul>
	For use only in the People's Republic of China
	<ul style="list-style-type: none"> <li>• 2 TB, 2280, PCIe-4×4, NVMe SSD with TLC</li> <li>• 1 TB, 2280, PCIe-4×4, NVMe SSD with TLC</li> <li>• 1 TB, 2280, PCIe, NVMe, value SSD</li> <li>• 512 GB, PCIe-4×4, NVMe SSD with TLC</li> <li>• 512 GB, 2280, PCIe, NVMe, SSD with TLC</li> <li>• 256 GB, 2280, PCIe, NVMe, value SSD</li> </ul>
<b>eMMC</b>	On-board embedded MultiMedia Controller (eMMC v5.0) 32 GB configuration (MLC/TLC) MO-276
<b>Audio and video</b>	Support for discrete amplifiers
	Support for discrete Poly Studio
	Support for quad speakers
	<b>Integrated HP Wide Vision Camera:</b> Fixed, USB 2.0, 5 MP, infrared, wide field-of-view (WFOV)
	Dual-array digital microphone with appropriate software: beam forming, echo cancellation, noise suppression
	Time-of-flight camera (ToF camera)
<b>Wireless</b>	<b>Wireless Local Area Network (WLAN)</b>
	Intel AX211 Wi-Fi® 6E + Bluetooth® 5.3 M.2 2230 vPro 160 MHz CNVi WW WLAN module
	Intel AX211 Wi-Fi 6E + Bluetooth 5.3 M.2 2230 non-vPro 160 MHz CNVi WW WLAN module
	Intel BE200 M.2 2230 Wi-Fi 7 + Bluetooth 5.4 vPro WW WLAN module
	Intel BE200 M.2 2230 Wi-Fi 7 + Bluetooth 5.4 non-vPro worldwide (WW) WLAN module

**Table 1-1 Product components and their descriptions (continued)**

Category	Description
	<b>Qualcomm 9205 LTE-M (CAT-M1 fSVC) WWAN module Wireless Wide Area Network (WWAN)</b>
<b>NFC module</b>	<b>Near Field Communication (NFC) Mirage WNC XRAV-1</b>
<b>Ports</b>	Hot plug/unplug and autodetect for correct output to wide-aspect vs. standard aspect video
	Audio-out (headphone)/audio-in (microphone) combo jack
	HDMI v2.0a supporting: up to 4096 × 2160 @ 60 Hz with HDCP 2.2
	USB 5 Gbps port with HP Sleep and Charge
	USB Type-C® power connector and 10 Gbps port with HP Sleep and Charge and DisplayPort™ output
	USB Type-C power connectors and Thunderbolt™ ports with HP Sleep and Charge and DisplayPort output (2)
<b>Keyboard/pointing devices</b>	<b>Keyboard</b>
	Full size, backlit, 3-coat paint, island style
	<b>Touchpad</b>
	Clickpad with image sensor
	Multitouch gestures enabled
	Precision touchpad support
	Support for Modern Trackpad Gestures
	Taps enabled as default
<b>Power requirements</b>	<b>Battery:</b> 6 cell, 68 Whr, polymer, HP Long Life battery and 3 cell, 56 Whr, polymer, HP Long Life battery
	HP Fast Charge Technology
	<b>AC adapters</b>
	Non-Power Factor Correction (nPFC) or Power Factor Correction (PFC)
	100 W, USB Type-C with straight, slim barrel
	65 W, USB Type-C with straight, slim barrel
	65 W, USB Type-C, halogen free (HF), with straight, slim barrel
	<b>Power cord</b>
	<ul style="list-style-type: none"> <li>● C5, 1.0 m (3.3 ft), conventional with sticker HF power cord</li> <li>● C5, 1.0 m (3.3 ft), conventional with sticker power cord</li> <li>● C5, 1.0 m (3.3 ft), premium with sticker power cord</li> </ul>
<b>Security</b>	<ul style="list-style-type: none"> <li>● Nano security lock</li> <li>● Integrated fingerprint reader</li> <li>● Privacy camera shutter door</li> </ul>
<b>Sensors</b>	<ul style="list-style-type: none"> <li>● HP Sure Platform</li> <li>● Hall sensor</li> <li>● Thermal sensor</li> </ul>

**Table 1-1 Product components and their descriptions (continued)**

<b>Category</b>	<b>Description</b>
<b>Operating system</b>	Windows® 11 Pro
	Windows 11 Pro Education
	Windows 11 Home - HP recommends Windows 11 Pro for Business
	Windows 11 Home Single Language - HP recommends Windows 11 Pro for Business
	Windows 11 Pro (Windows 11 Enterprise or Windows 10 Enterprise available with a Volume Licensing Agreement)
	Windows 11 Pro (preinstalled with Windows 10 Pro Downgrade)
	FreeDOS
<b>Serviceability</b>	<b>End user replaceable part:</b> AC adapter

## 2 Components

Your computer features top-rated components. This chapter provides details about your components, where they are located, and how they work.

### Locating hardware

Use these instructions to find out what hardware is installed on your computer.

- Select the **Search** icon in the taskbar, type `device manager` in the search box, and then select the **Device Manager** app.

A list displays all the devices installed on your computer.

For information about system hardware components and the system BIOS version number, press `fn+esc` (select products only).

### Locating software

Use these instructions to find out what software is installed on your computer:

- Right-click the **Start** button, and then select **Apps and Features**.

### Right

Use the illustration and table to identify the components on the right side of the computer.

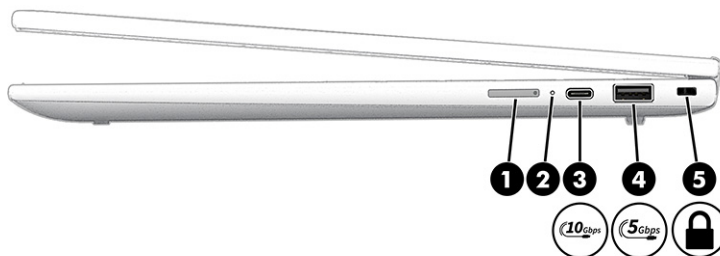

**Table 2-1** Right-side components and their descriptions

Component	Description
(1)	Nano SIM card slot (select products only) Supports a wireless subscriber identity module (SIM) card.

**Table 2-1 Right-side components and their descriptions (continued)**



Component	Description
(2) Battery light	<p>When AC power is connected:</p> <ul style="list-style-type: none"> <li>• White: The battery charge is greater than 90 percent.</li> <li>• Amber: The battery charge is from 0 to 90 percent.</li> <li>• Off: The battery is not charging.</li> </ul> <p>When AC power is disconnected (battery not charging):</p> <ul style="list-style-type: none"> <li>• Blinking amber: The battery has reached a low battery level. When the battery has reached a critical battery level, the battery light begins blinking rapidly.</li> <li>• Off: The battery is not charging.</li> </ul>
(3)  USB Type-C® power connector and 10 Gbps port with HP Sleep and Charge and DisplayPort™ output	<p>Connects an AC adapter that has a USB Type-C connector, supplying power to the computer and, if needed, charging the computer battery.</p> <p>- and -</p> <p>Connects a USB device, provides high-speed data transfer, and charges small devices (such as a smartphone), even when the computer is off.</p> <p><b>NOTE:</b> Use a standard USB Type-C charging cable or cable adapter (purchased separately) when charging a small external device.</p> <p>- and -</p> <p>Connects a display device that has a USB Type-C connector, providing DisplayPort output.</p>
(4)  USB 5 Gbps port with HP Sleep and Charge	<p>Connects a USB device, provides high-speed data transfer, and charges small devices (such as a smartphone), even when the computer is off.</p> <p><b>NOTE:</b> Use a standard USB Type-A charging cable or cable adapter (purchased separately) when charging a small external device.</p>
(5) Security cable slot	<p>Attaches an optional security cable to the computer.</p> <p><b>NOTE:</b> The security cable is designed to act as a deterrent, but it might not prevent the computer from being mishandled or stolen.</p>

## Left

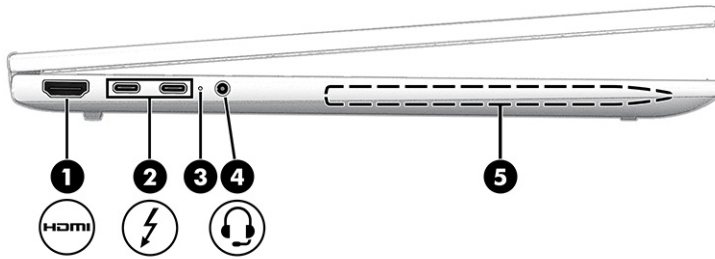
Use the illustration and table to identify the components on the left side of the computer.



**Table 2-2** Left-side components and their descriptions

Component	Description
(1)  HDMI port	Connects an optional video or audio device, such as a high-definition television, any compatible digital or audio component, or a high-speed High Definition Multimedia Interface (HDMI) device.
(2)  USB Type-C® power connectors and Thunderbolt™ ports with HP Sleep and Charge and DisplayPort output (2)	<p>Connect an AC adapter that has a USB Type-C connector, supplying power to the computer and, if needed, charging the computer battery.</p> <p>- and -</p> <p>Connect USB devices, provide high-speed data transfer, and charge small devices (such as a smartphone), even when the computer is off.</p> <p><b>NOTE:</b> Use a standard USB Type-C charging cable or cable adapter (purchased separately) when charging a small external device.</p> <p>- and -</p> <p>Connect a display device that has a USB Type-C connector, providing DisplayPort output.</p> <p><b>NOTE:</b> Your computer might also support a Thunderbolt docking station.</p>
(3) Battery light	<p>When AC power is connected:</p> <ul style="list-style-type: none"> <li>• White: The battery charge is greater than 90 percent.</li> <li>• Amber: The battery charge is from 0 to 90 percent.</li> <li>• Off: The battery is not charging.</li> </ul> <p>When AC power is disconnected (battery not charging):</p> <ul style="list-style-type: none"> <li>• Blinking amber: The battery has reached a low battery level. When the battery has reached a critical battery level, the battery light begins blinking rapidly.</li> <li>• Off: The battery is not charging.</li> </ul>

**Table 2-2** Left-side components and their descriptions (continued)

Component	Description
(4)  Audio-out (headphone)/Audio-in (microphone) combo jack	<p>Connects optional powered stereo speakers, headphones, earbuds, a headset, or a television audio cable. Also connects an optional headset microphone. This jack does not support optional standalone microphones.</p> <p><b>WARNING!</b> To reduce the risk of personal injury, adjust the volume before putting on headphones, earbuds, or a headset. For additional safety information, see the <i>Regulatory, Safety, and Environmental Notices</i>.</p> <p>To access this guide:</p> <ul style="list-style-type: none"><li>■ Select the <b>Search</b> icon in the taskbar, type <b>HP Documentation</b> in the search box, and then select <b>HP Documentation</b>.</li></ul> <p><b>NOTE:</b> When a device is connected to the jack, the computer speakers are disabled.</p>
(5) Magnetic pen attachment area (select products only)	Holds an optional pen.

## 360 modes (select products only)

If your computer offers 360 modes, the following illustration shows how you can use and fold your device.



# Display

Use the illustration and table to identify the display components.

## Auto Lock and Awake

Auto Lock and Awake monitors your presence in front of the computer to save power and add security.

When you step away from the computer, the proximity sensor puts the computer into the Sleep state. When you return to the computer, the sensor recognizes you and wakes the computer automatically. Auto Lock and Awake is turned on by default.

To access Auto Lock and Awake:

1. Select the **Start** button, select **Settings**, select **System**, and then select **Power & battery**.
2. Select **Screen and sleep**, and then follow the on-screen instructions.

## Low blue light mode (select products only)

Your computer display is shipped from the factory in low blue light mode for improved eye comfort and safety. Also, blue light mode automatically adjusts blue light emissions when you are using the computer at night or for reading.

**⚠ WARNING!** To reduce the risk of serious injury, read the *Safety & Comfort Guide*. It describes proper workstation setup and proper posture, health, and work habits for computer users. The *Safety & Comfort Guide* also provides important electrical and mechanical safety information. The *Safety & Comfort Guide* is available on the web at <http://www.hp.com/ergo>.

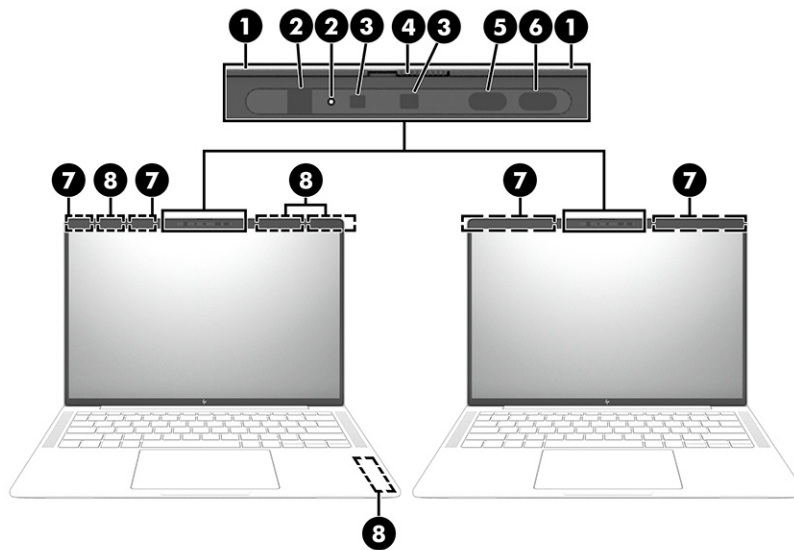

**Table 2-3** Display components and their descriptions

Component	Description
(1)	Internal microphones (2) Record sound.
(2)	Camera lights (2) On: One or more cameras are in use.

**Table 2-3 Display components and their descriptions (continued)**

Component	Description
(3) Cameras (2)	Allow you to video chat, record video, and record still images. Some cameras also allow a facial recognition logon to Windows, instead of a password logon.  <b>NOTE:</b> Camera functions vary depending on the camera hardware and software installed on your product.
(4) Camera privacy cover	By default, the camera lens is uncovered, but you can slide the camera privacy cover to block the camera's view. To use the camera, slide the camera privacy cover in the opposite direction to reveal the lens.  <b>NOTE:</b> If you have both front-facing and rear-facing cameras, when one camera lens is revealed and ready to use, the other is concealed.
(5) Ambient light and color sensor	Adjusts the brightness of the display, depending on the ambient light, and manages and controls the color temperature. Color temperature enables you to measure and adjust the warmth or coolness of the light source
(6) User-proximity sensor	Uses the Auto Lock and Awake feature to monitor your presence in front of the computer to save power and add security.
(7) WLAN antennas* (2)	Send and receive wireless signals to communicate with wireless local area networks (WLANs).
(8) WWAN antennas* (2) (select products only)	Send and receive wireless signals to communicate with wireless wide area networks (WWANs).

\*The antennas are not visible from the outside of the computer. For optimal transmission, keep the areas immediately around the antennas free from obstructions.

For wireless regulatory notices, see the section of the *Regulatory, Safety, and Environmental Notices* that applies to your country or region.

To access this guide:

- Select the **Search** icon in the taskbar, type `HP Documentation` in the search box, and then select **HP Documentation**.

# Keyboard area

Keyboards can vary by language.



**NOTE:** The keyboard, including the function keys and power key (select products only), is disabled in stand, tent, and tablet modes. To enable the keyboard, including the power key, change to the clamshell mode.

---

## Touchpad

The touchpad settings and components are described here.

### Touchpad settings

You learn how to adjust the touchpad settings and components here.

#### Adjusting touchpad settings

Use these steps to adjust touchpad settings and gestures.

1. Select the **Search** icon in the taskbar, type `touchpad settings` in the search box, and then press `enter`.
2. Choose a setting.

#### Turning on the touchpad

Follow these steps to turn on the touchpad.

1. Select the **Search** icon in the taskbar, type `touchpad settings` in the search box, and then press `enter`.
2. Using an external mouse, click the **Touchpad** button.

If you are not using an external mouse, press the `Tab` key repeatedly until the pointer rests on the **touchpad** button. Then press the `spacebar` to select the button.

### Touchpad components

Use the illustration and table to identify the touchpad components.

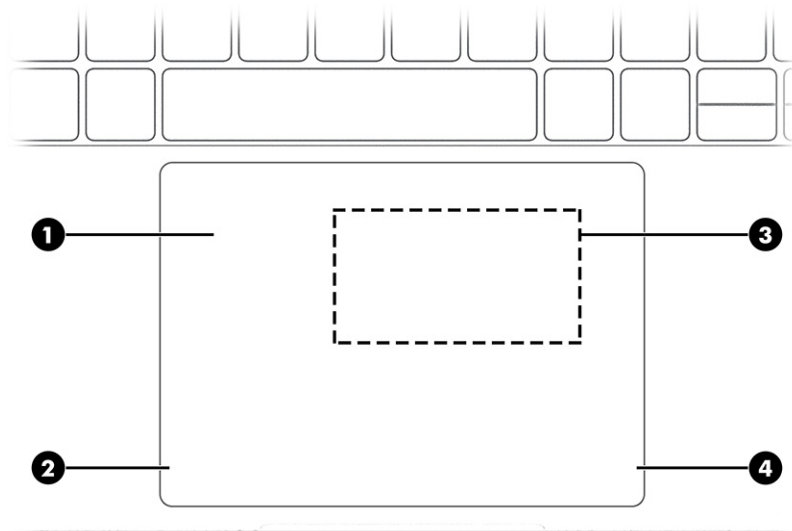
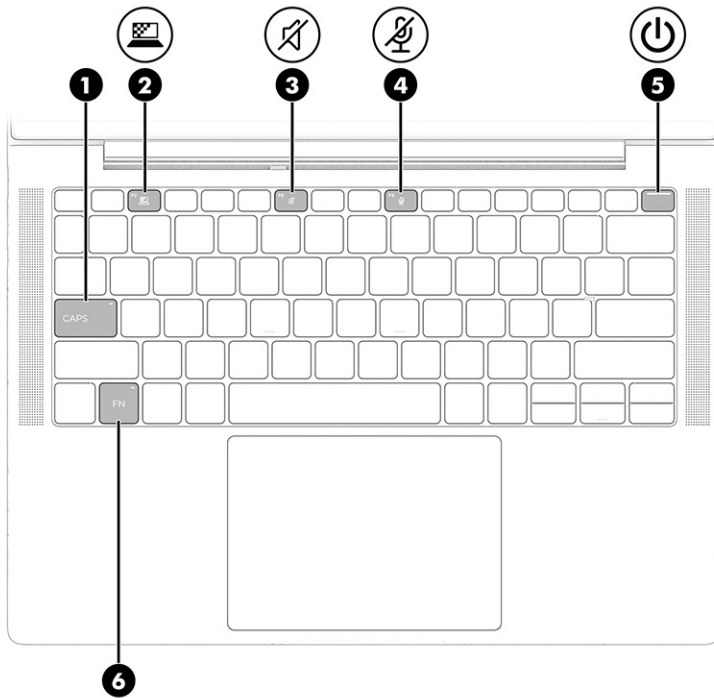

**Table 2-4** Touchpad components and their descriptions





Component	Description
(1) Touchpad zone	Reads your finger gestures to move the pointer or activate items on the screen.
(2) Left touchpad button	Functions like the left button on an external mouse.
(3) Near Field Communications (NFC) tapping area and antenna (select products only)	Allows you to wirelessly share information when you tap it with an NFC-enabled device.
(4) Right touchpad button	Functions like the right button on an external mouse.

## Lights

Use the illustration and table to identify the lights on the computer.



**Table 2-5** Lights and their descriptions

Component	Description
(1) Caps lock light	On: Caps lock is on, which switches the key input to all capital letters.
(2)  Privacy key light (select products only)	On: Privacy screen is on, which helps prevent side-angle viewing.
(3)  Mute light	<ul style="list-style-type: none"> <li>On: Computer sound is off.</li> <li>Off: Computer sound is on.</li> </ul>
(4)  Microphone mute light	<ul style="list-style-type: none"> <li>On: Microphone is off.</li> <li>Off: Microphone is on.</li> </ul>
(5)  Power light	<ul style="list-style-type: none"> <li>On: The computer is on.</li> <li>Blinking (select products only): The computer is in the Sleep state, a power-saving state. The computer shuts off power to the display and other unnecessary components.</li> <li>Off: Depending on your computer model, the computer is off, in Hibernation, or in Sleep. Hibernation is the power-saving state that uses the least amount of power.</li> </ul>
(6) Fn lock light	On: The <b>fn</b> key is locked.

## Button, speakers, and fingerprint reader

Fingerprint readers can be located on the touchpad, on a side panel of the computer, on the top cover below the keyboard, or on the power button.

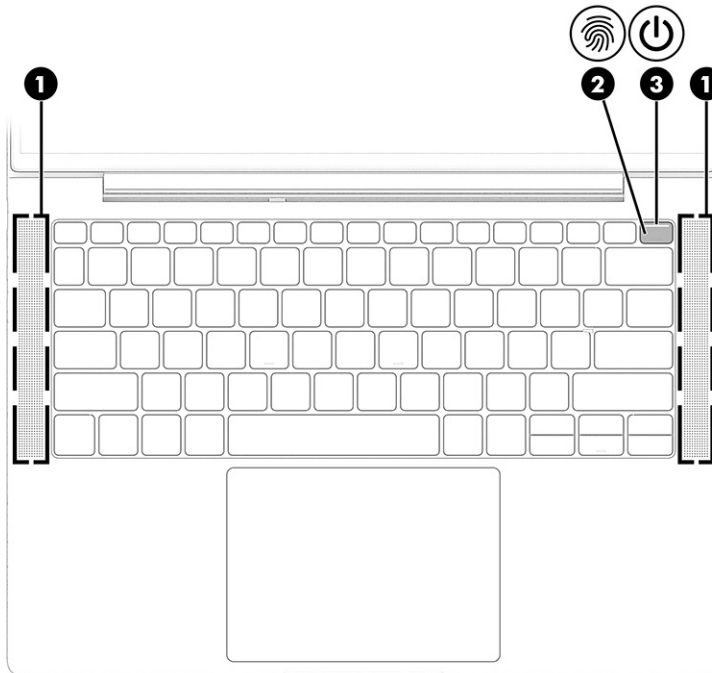

 **IMPORTANT:** To verify that your computer supports fingerprint reader sign-in, select the **Search** icon in the taskbar, type **Sign-in options** in the search box, and then select the **Sign-on options** app. If **Fingerprint recognition** is not listed as an option, then your notebook does not include a fingerprint reader.



**Table 2-6** Button, speakers, and fingerprint reader and their descriptions

Component	Description
(1) Speakers (2)	Produce sound.
(2) Fingerprint reader (select products only)	Allows a fingerprint logon to Windows, instead of a password logon. <ul style="list-style-type: none"><li>Touch your finger to the fingerprint reader.</li></ul> <p><b>IMPORTANT:</b> To prevent fingerprint logon issues, make sure when you register your fingerprint that all sides of your finger are registered by the fingerprint reader.</p>

**Table 2-6** Button, speakers, and fingerprint reader and their descriptions (continued)

Component	Description
(3)  Power button	<ul style="list-style-type: none"> <li>When the computer is off, press the button briefly to turn on the computer.</li> <li>When the computer is on, press the button briefly to initiate Sleep.</li> <li>When the computer is in the Sleep state, press the button briefly to exit Sleep (select products only).</li> <li>When the computer is in Hibernation, press the button briefly to exit Hibernation.</li> </ul> <p><b>IMPORTANT:</b> Pressing and holding down the power button results in the loss of unsaved information.</p> <p>If the computer has stopped responding and shutdown procedures are ineffective, press and hold the power button for at least 4 seconds to turn off the computer.</p> <p>To learn more about your power settings, use the Power icon.</p> <ul style="list-style-type: none"> <li>Right-click the <b>Power</b> icon , and then select <b>Power and sleep settings</b>.</li> </ul>

## Special keys



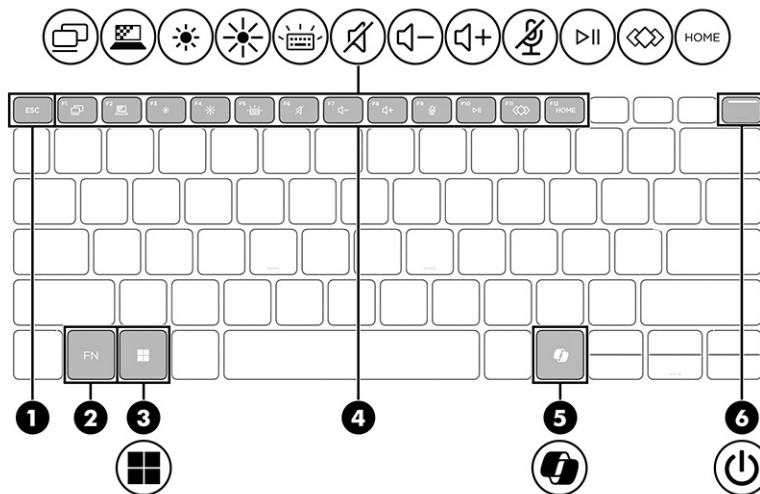

Use the illustration and table to identify the special keys.



**Table 2-7** Special keys and their descriptions

Component	Description
(1) <b>esc</b> key	Displays system information when pressed in combination with the <b>fn</b> key.
(2) <b>fn</b> key	Executes frequently used system functions when pressed in combination with another key. Such key combinations are called <i>hot keys</i> .

**Table 2-7** Special keys and their descriptions (continued)

Component	Description
(3)  Windows key	Opens the Start menu.  <b>NOTE:</b> Pressing the Windows key again closes the Start menu.
(4) Action keys	Execute frequently used system functions.
(5)  Windows Copilot key	Opens Windows Copilot (select products only).
(6)  Power button	<ul style="list-style-type: none"><li>• When the computer is off, press the button briefly to turn on the computer.</li><li>• When the computer is on, press the button briefly to initiate Sleep.</li><li>• When the computer is in the Sleep state, press the button briefly to exit Sleep (select products only).</li><li>• When the computer is in Hibernation, press the button briefly to exit Hibernation.</li></ul> <p><b>IMPORTANT:</b> Pressing and holding down the power button results in the loss of unsaved information.</p> <p>If the computer has stopped responding and shutdown procedures are ineffective, press and hold the power button for at least 4 seconds to turn off the computer.</p> <p>To learn more about your power settings, use the Power icon.</p> <ul style="list-style-type: none"><li>• Right-click the <b>Power</b> icon , and then select <b>Power and sleep settings</b>.</li></ul>

## Bottom

Use the illustration and table to identify the bottom components.

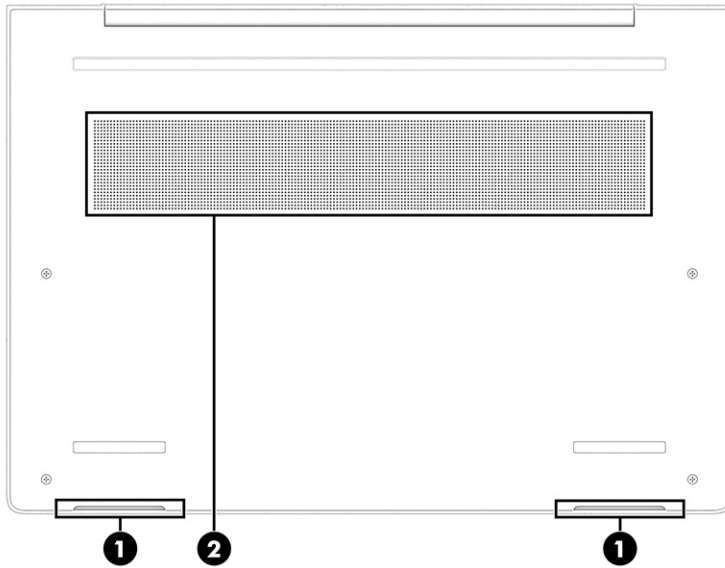

**Table 2-8** Bottom components and their descriptions

Component		Description
(1)	Speakers (2)	Produce sound.
(2)	Vent	Enables airflow to cool internal components.

**NOTE:** The computer fan starts up automatically to cool internal components and prevent overheating. It is normal for the internal fan to cycle on and off during routine operation.

## Rear

Use the illustration and table to identify the rear component.



**Table 2-9** Rear component and its description

Component	Description
Vent (select products only)	Enables airflow to cool internal components.

**NOTE:** The computer fan starts up automatically to cool internal components and prevent overheating. It is normal for the internal fan to cycle on and off during routine operation.

# Labels

The labels affixed to the computer provide information you might need when you troubleshoot system problems or travel internationally with the computer. Labels might be in paper form or imprinted on the product.

 **IMPORTANT:** Check the following locations for the labels described in this section: the bottom of the computer, inside the battery bay, under the service door, on the back of the display, or on the bottom of a tablet kickstand.

- Service label—Provides important information to identify your computer. When contacting support, you might be asked for the serial number, the product number, or the model number. Locate this information before you contact support.

Your service label will resemble one of the examples shown below. Refer to the illustration that most closely matches the service label on your computer.

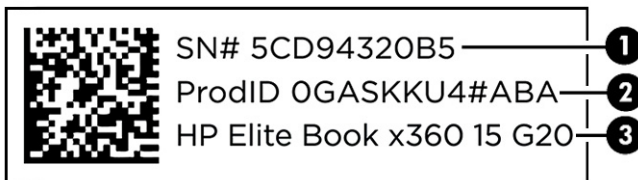

**Table 2-10** Service label components

Component	
(1)	Serial number
(2)	Product ID
(3)	HP product name

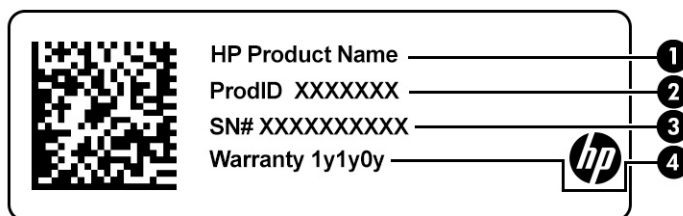

**Table 2-11** Service label components

Component	
(1)	HP product name
(2)	Product ID
(3)	Serial number
(4)	Warranty period

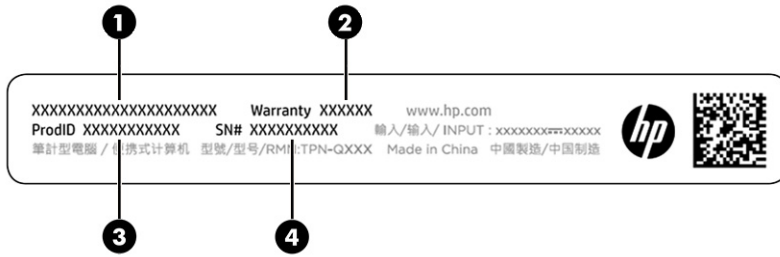

**Table 2-12 Service label components**

Component	
(1)	HP product name
(2)	Warranty period
(3)	Product ID
(4)	Serial number

- Regulatory labels—Provide regulatory information about the computer.
- Wireless certification labels—Provide information about optional wireless devices and the approval markings for the countries or regions in which the devices have been approved for use.

## Using a SIM card (select products only)

Use these instructions to insert a SIM card.

 **IMPORTANT:** You can damage the SIM card if you insert the wrong size card or insert it or the SIM card tray in the wrong direction. The card might also become stuck in the slot. Do not use SIM card adapters. To prevent damage to the SIM card or connectors, use minimal force when inserting or removing a SIM card.

### Determining the correct SIM card size for your computer

Before purchasing a SIM card, follow these instructions to determine the correct SIM card size for your computer.

1. Go to <http://www.hp.com/support>, and then search for your computer by product name or number.
2. Select **Product Information**.
3. Refer to the listed options to determine which card to purchase.

### Inserting a nano SIM card

To insert a nano SIM card, follow these steps.

1. Turn off the computer by using the **Shut down** command.
2. Insert a small straightened paper clip into the card tray access hole.
3. Press in gently on the clip until the card tray is ejected (1).
4. Remove the tray (2) from the computer and insert the card (3).
5. Replace the tray in the computer. Press in gently on the tray (4) until it is firmly seated.

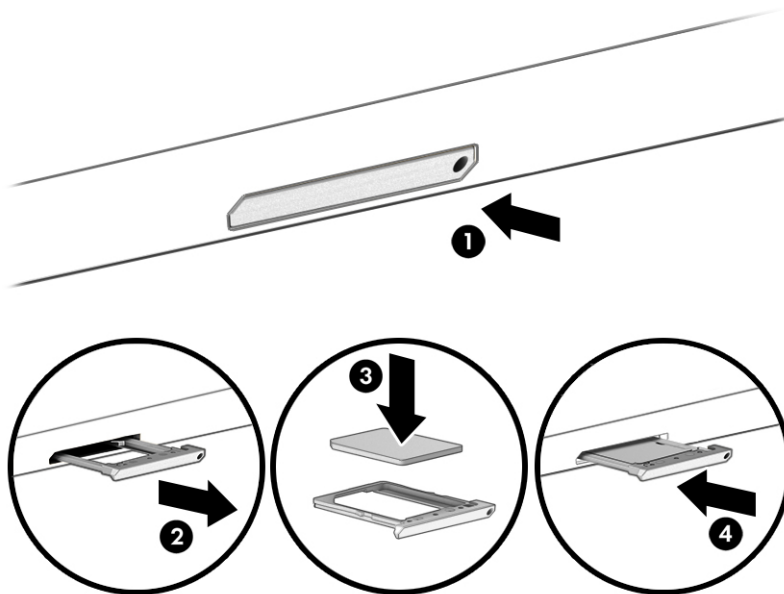

To remove the SIM card, insert a small straightened paper clip into the card tray access hole and press in gently on the clip. The tray will pop out of the slot. Remove the SIM card. Replace the tray in the computer and press in gently on the tray until it is firmly seated.

---

## 3 Illustrated parts catalog

Use this information to determine the spare parts that are available for the computer.

### Computer major components

To identify the computer major components, use this illustration and table.

---

 **NOTE:** HP continually improves and changes product parts. For complete and current information about supported parts for your computer, go to <http://partsurfer.hp.com>, select your country or region, and then follow the on-screen instructions.

 **NOTE:** Details about your computer, including model, serial number, product key, and length of warranty, are on the service tag at the bottom of your computer.

---

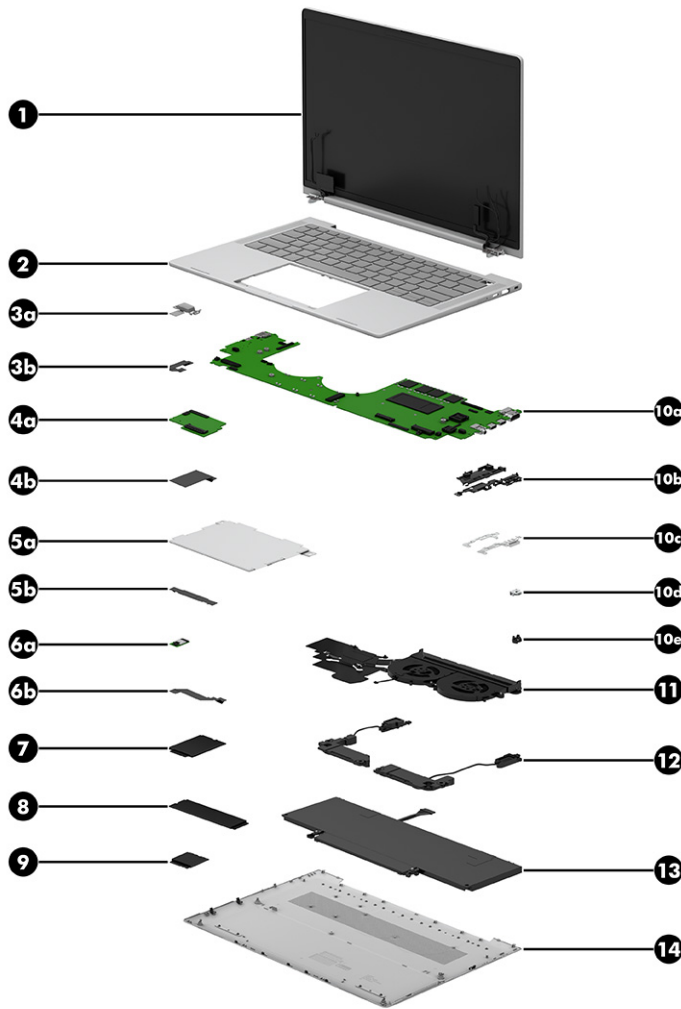

**Table 3-1 Computer major component descriptions and part numbers**

Item	Component	Spare part number
(1)	<b>Display assembly</b>	
	35.6 cm (14.0 in), brightview, UWVA, OLED + LBL, with infrared webcam, for use on computer models equipped with WLAN; typical brightness: 400 nits	N98092-001
	35.6 cm (14.0 in), brightview, UWVA, LBL, WUXGA, with infrared webcam, for use on computer models equipped with WWAN; typical brightness: 400 nits	N98091-001
	35.6 cm (14.0 in), brightview, UWVA, LBL, WUXGA, with infrared webcam, for use on computer models equipped with WLAN; typical brightness: 400 nits	N98090-001
	35.6 cm (14.0 in), brightview, UWVA, WUXGA, with TOF infrared webcam, for use on computer models equipped with WWAN and privacy filter; typical brightness: 1000 nits	N98089-001
	35.6 cm (14.0 in), brightview, UWVA, WUXGA, with TOF infrared webcam, for use on computer models equipped with WLAN and privacy filter; typical brightness: 1000 nits	N98088-001
	35.6 cm (14.0 in), brightview, UWVA, WUXGA, with TOF infrared webcam, for use on computer models equipped with WWAN and privacy filter; typical brightness: 800 nits	P04255-001
	35.6 cm (14.0 in), brightview, UWVA, WUXGA, with TOF infrared webcam, for use on computer models equipped with WLAN and privacy filter; typical brightness: 800 nits	P04254-001

**Table 3-1 Computer major component descriptions and part numbers (continued)**

Item	Component	Spare part number
	35.6 cm (14.0 in), antiglare, UWVA, LBL, WUXGA, with infrared webcam, for use on computer models equipped with WWAN; typical brightness: 400 nits	N98087-001
	35.6 cm (14.0 in), antiglare, UWVA, LBL, WUXGA, with infrared webcam, for use on computer models equipped with WLAN; typical brightness: 400 nits	N98086-001
	35.6 cm (14.0 in), antiglare, UWVA, WUXGA, with TOF infrared webcam, for use on computer models equipped with WWAN and privacy filter; typical brightness: 1000 nits	P04253-001
	35.6 cm (14.0 in), antiglare, UWVA, WUXGA, with TOF infrared webcam, for use on computer models equipped with WLAN and privacy filter; typical brightness: 1000 nits	P04252-001
	35.6 cm (14.0 in), antiglare, UWVA, WUXGA, with TOF infrared webcam, for use on computer models equipped with WWAN and privacy filter; typical brightness: 800 nits	N98085-001
	35.6 cm (14.0 in), antiglare, UWVA, WUXGA, with TOF infrared webcam, for use on computer models equipped with WLAN and privacy filter; typical brightness: 800 nits	N98084-001
<b>(2)</b>	<b>Top cover with keyboard</b>	
	Top cover with keyboard with backlight for use on computer models equipped with privacy filter (includes backlight cable and keyboard cable)	P04318-xxx
	Top cover with keyboard with backlight for use on computer models not equipped with privacy filter (includes backlight cable and keyboard cable)	P04319-xxx
	<b>NOTE:</b> For a detailed list of country codes, see <a href="#">Top cover with keyboard on page 69</a> .	
<b>(3a)</b>	<b>Fingerprint reader</b> (includes cable)	N98113-001
	<b>Power button</b> without fingerprint reader (not illustrated, includes cable)	N98114-001
<b>(3b)</b>	<b>Fingerprint reader cable</b>	
	<b>NOTE:</b> The fingerprint reader spare part kit does not include the fingerprint reader cable. The fingerprint reader cable is included in the Cable Kit, spare part number N98116-001.	
<b>(4a)</b>	<b>Transfer board</b> (includes cable)	N98118-001
<b>(4b)</b>	<b>Transfer board cable:</b> Included with the transfer board spare part kit, spare part number N98118-001.	
<b>(5a)</b>	<b>Touchpad</b>	
	<b>NOTE:</b> The touchpad spare part kit does not include the touchpad cable. The touchpad cable is included in the Cable Kit, spare part number N98116-001.	
	For use on computer models equipped with NFC (includes NFC module antenna)	N98120-001
	For use on computer models not equipped with NFC	N98119-001
<b>(5b)</b>	<b>Touchpad cable:</b> Included in the Cable Kit, spare part number N98116-001.	
<b>(6a)</b>	<b>NFC module</b>	N08706-001
	<b>NOTE:</b> The NFC module spare part kit does not include the NFC module. The NFC module cable is available using spare part number N94794-001.	
<b>(6b)</b>	<b>NFC module cable:</b> Included in the Cable Kit, spare part number N98116-001.	
<b>(7)</b>	<b>Qualcomm 9205 LTE-M (CAT-M1 fSVC) WWAN module</b>	N90688-001
<b>(8)</b>	<b>SSD</b>	
	For use in all countries and regions except the People's Republic of China	
	2 TB, M.2 2280, PCIe-4x4, ZTurbo SSD with TLC	M52027-001

**Table 3-1 Computer major component descriptions and part numbers (continued)**

Item	Component	Spare part number
	1 TB, 2280, PCIe-4×4, NVMe, SSD with TLC	M16560-001
	1 TB, M.2 2280, PCIe-4×4, NVMe, value SSD	N45474-001
	512 GB, M.2 2280, PCIe-4×4, NVMe, SSD	N45476-001
	512 GB, 2280, PCIe-4×4, NVMe, SSD with TLC	M17436-001
	512 GB, M.2 2280, PCIe-4×4, SSD with SED and TLC	M52031-001
	256 GB, M.2 2280, PCIe-4×4, NVMe, SSD	N45477-001
	256 GB, M.2 2280, PCIe-4×4, NVMe, SSD with SED and TLC	N35225-001
	For use only in the People's Republic of China	
	2 TB, 2280, PCIe-4×4, NVMe SSD with TLC	N77396-001
	1 TB, 2280, PCIe-4×4, NVMe, SSD with TLC	N77395-001
	1 TB, 2280, PCIe-4×4, NVMe, value SSD	N77394-001
	512 GB, 2280, PCIe-4×4, NVMe, SSD with TLC	N77393-001
	512 GB, 2280, PCIe-4×4, NVMe, value SSD	N77392-001
	256 GB, 2280, PCIe-4×4, NVMe, value SSD	N77391-001
	<b>SSD bracket</b> (not illustrated) Included in the Bracket Kit, spare part number N98115-001	
<b>(9)</b>	<b>WLAN module</b>	
	Intel AX211 Wi-Fi 6E + Bluetooth 5.3 M.2 2230 vPro 160 MHz CNVi WW WLAN module	M53363-001
	Intel AX211 Wi-Fi 6E + Bluetooth 5.3 M.2 2230 non-vPro 160 MHz CNVi WW WLAN module	M53366-001
	Intel BE200 M.2 2230 Wi-Fi 7 + Bluetooth 5.4 vPro WW WLAN module	N39882-00
	Intel BE200 M.2 2230 Wi-Fi 7 + Bluetooth 5.4 non-vPro WW WLAN module	N39883-001
<b>(10a)</b>	<b>System board</b> (includes integrated processor, a graphics subsystem with UMA memory, and replacement thermal material)	
	For use in all countries and regions except the People's Republic of China	
	Equipped with an Intel Core U7-165H processor, 32 GB of system memory, OSR, TIPD, and the Windows 11 operating system	N97665-601
	Equipped with an Intel Core U7-165H processor, 32 GB of system memory, OSR, TIPD, and a non-Windows operating system	N97665-001
	Equipped with an Intel Core U7-165H processor, 32 GB of system memory, TIPD, and the Windows 11 operating system	N97660-601
	Equipped with an Intel Core U7-165H processor, 32 GB of system memory, TIPD, and a non-Windows operating system	N97660-001
	Equipped with an Intel Core U7-165H processor, 16 GB of system memory, OSR, TIPD, and the Windows 11 operating system	N97664-601
	Equipped with an Intel Core U7-165H processor, 16 GB of system memory, OSR, TIPD, and a non-Windows operating system	N97664-001
	Equipped with an Intel Core U7-165H processor, 16 GB of system memory, TIPD, and the Windows 11 operating system	N97659-601

**Table 3-1 Computer major component descriptions and part numbers (continued)**

<b>Item</b>	<b>Component</b>	<b>Spare part number</b>
	Equipped with an Intel Core U7-165H processor, 16 GB of system memory, TIPD, and a non-Windows operating system	N97659-001
	Equipped with an Intel Core U7-155H processor, 32 GB of system memory, TIPD, and the Windows 11 operating system	N97658-601
	Equipped with an Intel Core U7-155H processor, 32 GB of system memory, TIPD, and a non-Windows operating system	N97658-001
	Equipped with an Intel Core U7-155H processor, 16 GB of system memory, TIPD, and the Windows 11 operating system	N97657-601
	Equipped with an Intel Core U7-155H processor, 16 GB of system memory, TIPD, and a non-Windows operating system	N97657-001
	Equipped with an Intel Core U5-135H processor, 32 GB of system memory, OSR, TIPD, and the Windows 11 operating system	N97663-601
	Equipped with an Intel Core U5-135H processor, 32 GB of system memory, OSR, TIPD, and a non-Windows operating system	N97663-001
	Equipped with an Intel Core U5-135H processor, 32 GB of system memory, TIPD, and the Windows 11 operating system	N97656-601
	Equipped with an Intel Core U5-135H processor, 32 GB of system memory, TIPD, and a non-Windows operating system	N97656-001
	Equipped with an Intel Core U5-135H processor, 16 GB of system memory, OSR, TIPD, and the Windows 11 operating system	N97662-601
	Equipped with an Intel Core U5-135H processor, 16 GB of system memory, OSR, TIPD, and a non-Windows operating system	N97662-001
	Equipped with an Intel Core U5-135H processor, 16 GB of system memory, TIPD, and the Windows 11 operating system	N97655-601
	Equipped with an Intel Core U5-135H processor, 16 GB of system memory, TIPD, and a non-Windows operating system	N97655-001
	Equipped with an Intel Core U5-135U processor, 16 GB of system memory, TIPD, and the Windows 11 operating system	N97654-601
	Equipped with an Intel Core U5-135U processor, 16 GB of system memory, TIPD, and a non-Windows operating system	N97654-001
	Equipped with an Intel Core U5-125H processor, 32 GB of system memory, TIPD, and the Windows 11 operating system	N97653-601
	Equipped with an Intel Core U5-125H processor, 32 GB of system memory, TIPD, and a non-Windows operating system	N97653-001
	Equipped with an Intel Core U5-125H processor, 16 GB of system memory, OSR, TIPD, and the Windows 11 operating system	N97661-601
	Equipped with an Intel Core U5-125H processor, 16 GB of system memory, OSR, TIPD, and a non-Windows operating system	N97661-001
	Equipped with an Intel Core U5-125H processor, 16 GB of system memory, TIPD, and the Windows 11 operating system	N97652-601
	Equipped with an Intel Core U5-125H processor, 16 GB of system memory, TIPD, and a non-Windows operating system	N97652-001
	For use only in the People's Republic of China	

**Table 3-1 Computer major component descriptions and part numbers (continued)**

<b>Item</b>	<b>Component</b>	<b>Spare part number</b>
	Equipped with an Intel Core U7-165H processor, 32 GB of system memory, TIPD, and the Windows 11 operating system	N97674-601
	Equipped with an Intel Core U7-165H processor, 32 GB of system memory, TIPD, and a non-Windows operating system	N97674-001
	Equipped with an Intel Core U7-165H processor, 16 GB of system memory, TIPD, and the Windows 11 operating system	N97673-601
	Equipped with an Intel Core U7-165H processor, 16 GB of system memory, TIPD, and a non-Windows operating system	N97673-001
	Equipped with an Intel Core U7-155H processor, 32 GB of system memory, TIPD, and the Windows 11 operating system	N97672-601
	Equipped with an Intel Core U7-155H processor, 32 GB of system memory, TIPD, and a non-Windows operating system	N97672-001
	Equipped with an Intel Core U7-155H processor, 16 GB of system memory, TIPD, and the Windows 11 operating system	N97671-601
	Equipped with an Intel Core U7-155H processor, 16 GB of system memory, TIPD, and a non-Windows operating system	N97671-001
	Equipped with an Intel Core U5-135H processor, 32 GB of system memory, TIPD, and the Windows 11 operating system	N97670-601
	Equipped with an Intel Core U5-135H processor, 32 GB of system memory, TIPD, and a non-Windows operating system	N97670-001
	Equipped with an Intel Core U5-135H processor, 16 GB of system memory, TIPD, and the Windows 11 operating system	N97669-601
	Equipped with an Intel Core U5-135H processor, 16 GB of system memory, TIPD, and a non-Windows operating system	N97669-001
	Equipped with an Intel Core U5-135U processor, 16 GB of system memory, TIPD, and the Windows 11 operating system	N97666-601
	Equipped with an Intel Core U5-135U processor, 16 GB of system memory, TIPD, and a non-Windows operating system	N97666-001
<b>(10b)</b>	<b>Left and right I/O bracket holders:</b> Included in the Plastics Kit, spare part number N98117-001	
<b>(10c)</b>	<b>Left and right I/O brackets:</b> Included in the Bracket Kit, spare part number N98115-001	
<b>(10d)</b>	<b>Middle hook holder:</b> Included in the Plastics Kit, spare part number N98117-001	
<b>(10e)</b>	<b>Security bracket:</b> Not available as a spare part	
<b>(11)</b>	<b>Fan/heat sink assembly</b> (includes captive screws and replacement thermal material)	N98097-001
<b>(12)</b>	<b>Speakers</b> (includes left and right speakers, cables, and six rubber isolators)	N98096-001
<b>(13)</b>	<b>Battery</b> (includes cable)	
	6 cell, 68 Whr, Li-ion battery	N59788-005
	3 cell, 56 Whr, Li-ion battery	P05235-001
<b>(14)</b>	<b>Bottom cover</b> (includes one long rubber foot and two short rubber feet)	
	For use only on computer models equipped with WWAN capability	N98094-001
	For use only on computer models not equipped with WWAN capability	N98093-001

## Miscellaneous parts

To identify the miscellaneous parts, use this table.

**Table 3-2** Miscellaneous part descriptions and part numbers

Component	Spare part number
<b>AC adapter</b>	
280 W AC adapter (PFC, 3 prong, 7.4 mm, slim)	M52952-001
120 W HP Smart adapter (PFC, 7.4 mm, slim)	L89695-001
120 W HP Smart adapter (PFC, RC, 4.5 mm, slim)	M95377-001
100 W AC adapter (nPFC, 3 prong, USB Type-C PD)	N57045-001
65 W AC adapter (nPFC, 3 prong, USB Type-C, slim)	M54350-001
65 W AC adapter 65W (nPFC, USB Type-C, 1.8 m [6.6 ft])	L67440-001
65 W AC adapter (nPFC, USB Type-C, 1.8 m [6.6 ft], HF)	N90678-001
65 W AC adapter (PD)	P02292-001
65 W AC adapter (USB Type-C)	N05175-001
<b>Adapter</b>	
HP HDMI-to-VGA adapter	701943-001
HP USB 3.0-to-Gigabit RJ45 adapter	M95984-001
HP USB Type-C-to-DisplayPort adapter	831753-001
HP USB Type-C-to-HDMI 2.0 adapter	935325-001
HP USB Type-C-to-RJ45 adapter	M95985-001
USB Type-C-to-USB Type-A adapter	L65254-001
USB Type-C-to-DisplayPort G2 adapter and cable	N81435-001
<b>Backpack</b>	
HP 14.1 inch Business slim top load backpack	L05333-001
HP 16 inch Executive laptop backpack	N19979-001
HP Prelude Pro 15.6 inch backpack	M03617-001
HP Prelude Pro 15.6 inch top load backpack	M03618-001
<b>Bag</b>	
HP 14.1 inch Business laptop bag	M55007-001
HP 16 inch Executive laptop bag	M19980-001
<b>Bracket Kit</b> (includes I/O brackets, memory module shields, SIM tray, and SSD shield)	N98115-001
<b>Cable</b>	
HP Thunderbolt G4 280 W cable (0.8 m [2.6 ft])	M88059-001
HP Thunderbolt G4 120 W cable (0.8 m [2.6 ft])	M88058-001
USB Type-C male-to-USB Type-A male cable (1.0 m [3.3 ft])	L65353-001

**Table 3-2 Miscellaneous part descriptions and part numbers (continued)**

<b>Component</b>	<b>Spare part number</b>
<b>Cable Kit</b> (includes fingerprint reader cable, NFC module cable, and touchpad cable)	N98116-001
<b>Dock</b>	
HP Thunderbolt G4 280 W dock (includes combination cable)	M97106-001
HP Thunderbolt G4 120 W dock (includes cable)	M97105-001
HP Thunderbolt 120 W dock (includes cable)	L15809-001
HP USB Type-C dock (includes cable)	N64086-001
Bottom case for HP USB Type-C dock	L65256-001
HP USB Type-C G5 Essential dock	N31329-001
HP USB Type-A/-C universal dock (includes cable)	L64087-001
Bottom case for HP USB Type-A/-C universal dock	L64088-001
<b>HP USB External DVD+RW Drive</b>	747080-001
<b>Duck head adapter</b> (for use in Japan)	L33157-001
<b>Headset</b> (VY, 60 UC, with touchscreen)	N73088-001
<b>Hub</b>	
HP universal USB Type-C multidevice hub	M96822-001
USB Type-C G3, multiport, travel	N60372-001
<b>HP USB keyboard</b> (United States layout)	L95712-001
<b>Lock</b>	
HP Essential nano combination cable lock	N10501-001
HP nano combination cable lock	N10500-001
HP nano lock	918431-001
<b>Mouse</b>	
HP 435 wireless mouse	M62277-001
HP 715 black multidevice mouse	N21845-001
HP 935 Creator mouse	M16122-001
HP USB mouse	N95713-001
<b>Power cord</b> (C5, 1.0 m [3.3 ft], conventional with sticker) + AC adapter bundle for use in Thailand	M85418-001
<b>Power cord</b> (C5, 1.0 m [3.3 ft], conventional with sticker):	
For use in Argentina	L19357-001
For use in Australia	L19358-001
For use in Brazil	L19359-001
For use in Denmark	L19360-001
For use in Europe	L19361-001
For use in India	L19363-001

**Table 3-2 Miscellaneous part descriptions and part numbers (continued)**

<b>Component</b>	<b>Spare part number</b>
For use in Israel	L19362-001
For use in Italy	L19364-001
For use in Japan	L19365-001
For use in North America	L19367-001
For use in the People's Republic of China	L19368-001
For use in South Africa	L19369-001
For use in South Korea	L19366-001
For use in Switzerland	L19370-001
For use in Taiwan	L19372-001
For use in Thailand	L19371-001
For use in the United Kingdom	L19373-001
<b>Power cord</b> (C5, 1.0 m [3.3 ft], conventional with sticker, HF):	
For use in Denmark	M79264-001
For use in Europe	M79266-001
For use in Israel	M82712-001
For use in Switzerland	M79265-001
For use in the United Kingdom	M82711-001
<b>Power cord</b> (C5, 1.0 m [3.3 ft], premium with sticker) + AC adapter bundle for use in Thailand	M85421-001
<b>Power cord</b> (C5, 1.0 m [3.3 ft], premium with sticker):	
For use in Argentina	L30811-001
For use in Australia	L22327-001
For use in Brazil	L30812-001
For use in Denmark	L22322-001
For use in Europe	L22321-001
For use in India	L22624-001
For use in Israel	L22323-001
For use in Italy	L30813-001
For use in Japan	L22330-001
For use in North America	L22319-001
For use in the People's Republic of China	L21930-001
For use in South Africa	L22325-001
For use in South Korea	L22328-001
For use in Switzerland	L22324-001
For use in Taiwan	L22329-001

**Table 3-2** Miscellaneous part descriptions and part numbers (continued)

<b>Component</b>	<b>Spare part number</b>
For use in Thailand	L22326-001
For use in the United Kingdom	L22320-001
<b>Power cord</b> (C5, 1.0 m [3.3 ft], premium with sticker, NP):	
For use in Argentina	L42493-001
For use in Australia	L42486-001
For use in Denmark	L42487-001
For use in Europe	L42488-001
For use in Israel	L42489-001
For use in Japan	L42490-001
For use in North America	L42492-001
For use in South Korea	L42491-001
For use in Switzerland	L42494-001
For use in Taiwan	L42496-001
For use in Thailand	L42495-001
For use in the United Kingdom	L42497-001
<b>Power cord</b> (C5, 1.8 m [6.0 ft], conventional with sticker):	
For use in Argentina	L19357-002
For use in Australia	L19358-002
For use in Brazil	L19359-002
For use in Denmark	L19360-002
For use in Europe	L19361-002
For use in India	L19363-002
For use in Israel	L19362-002
For use in Italy	L19364-002
For use in Japan	L19365-002
For use in North America	L19367-002
For use in the People's Republic of China	L19368-002
For use in South Africa	L19369-002
For use in South Korea	L19366-002
For use in Switzerland	L19370-002
For use in Taiwan	L19372-002
For use in Thailand	L19371-002
For use in the United Kingdom	L19373-002
<b>Power cord</b> (C5, 1.8 m [6.0 ft], premium with sticker, DH, FX for use in Brazil)	L19341-002

**Table 3-2** Miscellaneous part descriptions and part numbers (continued)

<b>Component</b>	<b>Spare part number</b>
<b>Power cord</b> (C13, 1.0 m [3.3 ft], premium with tag)	
For use in Argentina	L32029-001
For use in Brazil	L32030-001
For use in Italy	L32031-001
<b>Power cord</b> (C13, 1.0 m [3.3 ft], premium with tag LW)	
For use in Australia	N24670-002
For use in Denmark	N24672-001
For use in Europe	N24669-001
For use in India	N24679-001
For use in Israel	N24678-001
For use in Japan	N24680-001
For use in North America	N24671-001
For use in the People's Republic of China	N24676-001
For use in South Africa	N24674-001
For use in South Korea	N24675-001
For use in Switzerland	N24673-001
For use in Taiwan	N24677-001
For use in the United Kingdom	N24668-001
<b>Screw Kit</b>	N91036-001

---

## 4 Removal and replacement procedures preliminary requirements

Use this information to properly prepare to disassemble and reassemble the computer.

### Tools required

You need the following tools to complete the removal and replacement procedures:

- Tweezers
- Nonconductive, nonmarking pry tool
- Magnetic Phillips P1 screwdriver

## Service considerations

The following sections include some of the considerations that you must keep in mind during disassembly and assembly procedures.



---

**NOTE:** As you remove each subassembly from the computer, place the subassembly (and all accompanying screws) away from the work area to prevent damage.

---

### Plastic parts

Using excessive force during disassembly and reassembly can damage plastic parts.

### Cables and connectors

Handle cables with extreme care to avoid damage.



---

**IMPORTANT:** When servicing the computer, be sure that cables are placed in their proper locations during the reassembly process. Improper cable placement can damage the computer.

---

Apply only the tension required to unseat or seat the cables during removal and insertion. Handle cables by the connector whenever possible. In all cases, avoid bending, twisting, or tearing cables. Be sure that cables are routed so that they cannot be caught or snagged as you remove or replace parts. Handle flex cables with extreme care; these cables tear easily.

### Drive handling

Note the following guidelines when handling drives.



---

**IMPORTANT:** Drives are fragile components. Handle them with care. To prevent damage to the computer, damage to a drive, or loss of information, observe these precautions:

- Before removing or inserting a hard drive, shut down the computer. If you are unsure whether the computer is off or in Hibernation, turn the computer on, and then shut it down through the operating system.
  - Before handling a drive, be sure that you are discharged of static electricity. While handling a drive, avoid touching the connector.
  - Before removing an optical drive, be sure that a disc is not in the drive, and be sure that the optical drive tray is closed.
  - Handle drives on surfaces covered with at least 2.54 cm (1 inch) of shock-proof foam.
  - Avoid dropping drives from any height onto any surface.
  - After removing a hard drive or an optical drive, place it in a static-proof bag.
  - Avoid exposing an internal hard drive to products that have magnetic fields, such as monitors or speakers.
  - Avoid exposing a drive to temperature extremes or liquids.
  - If a drive must be mailed, place the drive in a bubble pack mailer or other suitable form of protective packaging, and label the package “FRAGILE.”
-

# Electrostatic discharge information

A sudden discharge of static electricity from your finger or other conductor can destroy static-sensitive devices or microcircuitry. Often the spark is neither felt nor heard, but damage occurs. An electronic device exposed to electrostatic discharge (ESD) might not appear to be affected at all and can work perfectly throughout a normal cycle. The device might function normally for a while, but it has been degraded in the internal layers, reducing its life expectancy.

Networks built into many integrated circuits provide some protection, but in many cases, the discharge contains enough power to alter device parameters or melt silicon junctions.

 **IMPORTANT:** To prevent damage to the device when you remove or install internal components, observe these precautions:

- Keep components in their electrostatic-safe containers until you are ready to install them.
- Before touching an electronic component, discharge static electricity by using the guidelines described in [Personal grounding methods and equipment on page 36](#).
- Avoid touching pins, leads, and circuitry. Handle electronic components as little as possible.
- If you remove a component, place it in an electrostatic-safe container.

## Generating static electricity

Follow these static electricity guidelines:

- Different activities generate different amounts of static electricity.
- Static electricity increases as humidity decreases.

**Table 4-1 Static electricity occurrence based on activity and humidity**

Event	Relative humidity		
	55%	40%	10%
Walking across carpet	7,500 V	15,000 V	35,000 V
Walking across vinyl floor	3,000 V	5,000 V	12,000 V
Motions of bench worker	400 V	800 V	6,000 V
Removing dual in-line packages (DIPs) from plastic tube	400 V	700 V	2,000 V
Removing DIPs from vinyl tray	2,000 V	4,000 V	11,500 V
Removing DIPs from polystyrene foam	3,500 V	5,000 V	14,500 V
Removing bubble pack from PCB (printed circuit board)	7,000 V	20,000 V	26,500 V
Packing PCBs in foam-lined box	5,000 V	11,000 V	21,000 V

 **NOTE:** Multiple electric components can be packaged together in plastic tubes, trays, or polystyrene foam.

As little as 700 V of static electricity can degrade a product.

## Preventing electrostatic damage to equipment

Many electronic components are sensitive to ESD. Circuitry design and structure determine the degree of sensitivity.

The following packaging and grounding precautions are necessary to prevent static electricity damage to electronic components:

- To avoid hand contact, transport products in static-safe containers such as tubes, bags, or boxes.
- Protect all electrostatic parts and assemblies with conductive or approved containers or packaging.
- Keep electrostatic-sensitive parts in their containers until they arrive at static-free stations.
- Place items on a grounded surface before removing them from their container.
- Always be properly grounded when touching a sensitive component or assembly.
- Avoid contact with pins, leads, or circuitry.
- Place reusable electrostatic-sensitive parts from assemblies in protective packaging or conductive foam.

## Personal grounding methods and equipment

Using certain equipment can prevent static electricity damage to electronic components.

- **Wrist straps** are flexible straps with a maximum of  $1\text{ M}\Omega \pm 10\%$  resistance in the ground cords. To provide proper ground, a strap must be worn snug against bare skin. The ground cord must be connected and fit snugly into the banana plug connector on the grounding mat or workstation.
- You can use **heel straps, toe straps, and boot straps** at standing workstations. These straps are compatible with most types of shoes or boots. On conductive floors or dissipative floor mats, use them on both feet with a maximum of  $1\text{ M}\Omega \pm 10\%$  resistance between the operator and ground.

**Table 4-2 Static shielding protection levels**

Static shielding protection levels	
Method	Voltage
Antistatic plastic	1,500
Carbon-loaded plastic	7,500
Metallized laminate	15,000

## Grounding the work area

To prevent static damage at the work area, follow these precautions:

- Cover the work surface with approved static-dissipative material.
- Use a wrist strap connected to a properly grounded work surface and use properly grounded tools and equipment.
- Use static-dissipative mats, foot straps, or air ionizers to give added protection.
- Handle electrostatic sensitive components, parts, and assemblies by the case or PCB laminate. Handle them only at static-free work areas.

- Turn off power and input signals before inserting and removing connectors or test equipment.
- Use fixtures made of static-safe materials when fixtures must directly contact dissipative surfaces.
- Keep the work area free of nonconductive materials, such as ordinary plastic assembly aids and polystyrene foam.
- Use conductive field service tools, such as cutters, screwdrivers, and vacuums.
- Avoid contact with pins, leads, or circuitry.

## Recommended materials and equipment

HP recommends certain materials and equipment to prevent static electricity:

- Antistatic tape
- Antistatic smocks, aprons, or sleeve protectors
- Conductive bins and other assembly or soldering aids
- Conductive foam
- Conductive tabletop workstations with ground cord of  $1\text{ M}\Omega \pm 10\%$  resistance
- Static-dissipative table or floor mats with hard tie to ground
- Field service kits
- Static awareness labels
- Wrist straps and footwear straps providing  $1\text{ M}\Omega \pm 10\%$  resistance
- Material handling packages
- Conductive plastic bags
- Conductive plastic tubes
- Conductive tote boxes
- Opaque shielding bags
- Transparent metallized shielding bags
- Transparent shielding tubes

# Cleaning your computer

Cleaning your computer regularly removes dirt and debris so that your device continues to operate at its best. Use the following information to safely clean the external surfaces of your computer.

## Enabling HP Easy Clean (select products only)

HP Easy Clean helps you to avoid accidental input while you clean the computer surfaces. This software disables devices such as the keyboard, touch screen, and touchpad for a preset amount of time so that you can clean all computer surfaces.

1. Start HP Easy Clean in one of the following ways:
  - Select the **Start** menu, and then select **HP Easy Clean**.
  - Select the **HP Easy Clean** icon in the taskbar.
  - Select **Start**, and then select the **HP Easy Clean** tile.
2. Now that your device is disabled for a short period, see [Removing dirt and debris from your computer on page 38](#) for the recommended steps to clean the high-touch, external surfaces on your computer. After you remove the dirt and debris, you can also clean the surfaces with a disinfectant. See [Cleaning your computer with a disinfectant on page 39](#) for guidelines to help prevent the spread of harmful bacteria and viruses.

## Removing dirt and debris from your computer

Here are the recommended steps to clean dirt and debris from your computer.

For computers with wood veneer, see [Caring for wood veneer \(select products only\) on page 40](#).

1. Wear disposable gloves made of latex (or nitrile gloves, if you are latex-sensitive) when cleaning the surfaces.
2. Turn off your device and unplug the power cord and other connected external devices. Remove any installed batteries from items such as wireless keyboards.

---

 **CAUTION:** To prevent electric shock or damage to components, never clean a product while it is turned on or plugged in.

---

3. Moisten a microfiber cloth with water. The cloth should be moist, but not dripping wet.

---

 **IMPORTANT:** To avoid damaging the surface, avoid abrasive cloths, towels, and paper towels.

---

4. Wipe the exterior of the product gently with the moistened cloth.

---

 **IMPORTANT:** Keep liquids away from the product. Avoid getting moisture in any openings. If liquid makes its way inside your HP product, it can cause damage to the product. Do not spray liquids directly on the product. Do not use aerosol sprays, solvents, abrasives, or cleaners containing hydrogen peroxide or bleach that might damage the finish.

---

5. Start with the display (if applicable). Wipe carefully in one direction, and move from the top of the display to the bottom. Finish with any flexible cables, like power cord, keyboard cable, and USB cables.
6. Be sure that surfaces have completely air-dried before turning the device on after cleaning.

7. Discard the gloves after each cleaning. Clean your hands immediately after you remove the gloves.

See [Cleaning your computer with a disinfectant on page 39](#) for recommended steps to clean the high-touch, external surfaces on your computer to help prevent the spread of harmful bacteria and viruses.

## Cleaning your computer with a disinfectant

The World Health Organization (WHO) recommends cleaning surfaces, followed by disinfection, as a best practice for preventing the spread of viral respiratory illnesses and harmful bacteria.

After cleaning the external surfaces of your computer using the steps in [Removing dirt and debris from your computer on page 38](#), [Caring for wood veneer \(select products only\) on page 40](#), or both, you might also choose to clean the surfaces with a disinfectant. A disinfectant that is within HP's cleaning guidelines is an alcohol solution consisting of 70% isopropyl alcohol and 30% water. This solution is also known as rubbing alcohol and is sold in most stores.

Follow these steps when disinfecting high-touch, external surfaces on your computer:

1. Wear disposable gloves made of latex (or nitrile gloves, if you are latex-sensitive) when cleaning the surfaces.
2. Turn off your device and unplug the power cord and other connected external devices. Remove any installed batteries from items such as wireless keyboards.

---

 **CAUTION:** To prevent electric shock or damage to components, never clean a product while it is turned on or plugged in.

---

3. Moisten a microfiber cloth with a mixture of 70% isopropyl alcohol and 30% water. The cloth should be moist, but not dripping wet.

---

 **CAUTION:** Do not use any of the following chemicals or any solutions that contain them, including spray-based surface cleaners: bleach, peroxides (including hydrogen peroxide), acetone, ammonia, ethyl alcohol, methylene chloride, or any petroleum-based materials, such as gasoline, paint thinner, benzene, or toluene.

---

 **IMPORTANT:** To avoid damaging the surface, avoid abrasive cloths, towels, and paper towels.

---

4. Wipe the exterior of the product gently with the moistened cloth.

---

 **IMPORTANT:** Keep liquids away from the product. Avoid getting moisture in any openings. If liquid makes its way inside your HP product, it can cause damage to the product. Do not spray liquids directly on the product. Do not use aerosol sprays, solvents, abrasives, or cleaners containing hydrogen peroxide or bleach that might damage the finish.

---

5. Start with the display (if applicable). Wipe carefully in one direction, and move from the top of the display to the bottom. Finish with any flexible cables, like power cord, keyboard cable, and USB cables.
6. Be sure that surfaces have completely air-dried before turning the device on after cleaning.
7. Discard the gloves after each cleaning. Clean your hands immediately after you remove the gloves.

## Caring for wood veneer (select products only)

Your product might feature high-quality wood veneer. As with all natural wood products, proper care is important for best results over the life of the product. Because of the nature of natural wood, you might see unique variations in the grain pattern or subtle variations in color, which are normal.

- Clean the wood with a dry, static-free microfiber cloth or chamois.
- Avoid cleaning products containing substances such as ammonia, methylene chloride, acetone, turpentine, or other petroleum-based solvents.
- Do not expose the wood to sun or moisture for long periods of time.
- If the wood becomes wet, dry it by dabbing with an absorbent, lint-free cloth.
- Avoid contact with any substance that might dye or discolor the wood.
- Avoid contact with sharp objects or rough surfaces that might scratch the wood.

See [Removing dirt and debris from your computer on page 38](#) for the recommended steps to clean the high-touch, external surfaces on your computer. After you remove the dirt and debris, you can also clean the surfaces with a disinfectant. See [Cleaning your computer with a disinfectant on page 39](#) for sanitizing guidelines to help prevent the spread of harmful bacteria and viruses.

## Packaging and transporting guidelines

Follow these grounding guidelines when packaging and transporting equipment:

- To avoid hand contact, transport products in static-safe tubes, bags, or boxes.
- Protect ESD-sensitive parts and assemblies with conductive or approved containers or packaging.
- Keep ESD-sensitive parts in their containers until the parts arrive at static-free workstations.
- Place items on a grounded surface before removing items from their containers.
- Always be properly grounded when touching a component or assembly.
- Store reusable ESD-sensitive parts from assemblies in protective packaging or nonconductive foam.
- Use transporters and conveyors made of antistatic belts and roller bushings. Be sure that mechanized equipment used for moving materials is wired to ground and that proper materials are selected to avoid static charging. When grounding is not possible, use an ionizer to dissipate electric charges.

## Accessing support information

To find the HP support that you need, use this information.

**Table 4-3 Support information locations**

Service consideration	Path to access information
Records of reported failure incidents stored on the computer	<p><b>Windows®:</b></p> <p>Preoperating system failures are logged in the BIOS Event Log. To view the BIOS Event Log:</p> <ol style="list-style-type: none"><li>1. Press the power button.</li><li>2. Immediately and repeatedly press <b>esc</b> when the power button light turns white.</li></ol> <p><b>NOTE:</b> If you do not press <b>esc</b> at the appropriate time, you must restart the computer and again repeatedly press <b>esc</b> when the power button light turns white to access the utility.</p> <ol style="list-style-type: none"><li>3. Press <b>f10</b> to enter the BIOS setup.</li><li>4. (On commercial products) Under the <b>Main</b> tab, select <b>BIOS event log</b>, and then select <b>View BIOS Event Log</b>.</li></ol> <p>- or -</p> <p>(On consumer products) Under the <b>Main</b> tab, select <b>System Log</b>.</p> <p>Post-operating system failures are logged in the Event Viewer.</p> <ol style="list-style-type: none"><li>1. Turn on the computer and allow the operating system to open.</li><li>2. Select the search icon  in the taskbar.</li><li>3. Type <code>Event Viewer</code>, and then press <b>enter</b>.</li><li>4. Select the log from the left panel. Details display in the right panel.</li></ol> <p><b>Chrome™:</b></p> <ol style="list-style-type: none"><li>1. Go to <a href="https://support.google.com/chrome">support.google.com/chrome</a>.</li><li>2. Search <code>collect Chrome device logs</code>.</li></ol>
Technical bulletins	<p>To locate technical bulletins:</p> <ol style="list-style-type: none"><li>1. Go to <a href="https://www.hp.com">www.hp.com</a>.</li><li>2. Place the cursor over <b>Problem solving</b> to display more options.</li><li>3. Select <b>Support &amp; Troubleshooting</b>.</li><li>4. Type the serial number, product number, or product name to go to the product support page.</li><li>5. Select <b>Advisories</b> to view technical bulletins.</li></ol>
Repair professionals	<p>To locate repair professionals:</p> <ol style="list-style-type: none"><li>1. Go to <a href="https://www.hp.com">www.hp.com</a>.</li><li>2. Place the cursor over <b>Support resources</b> to display more options.</li><li>3. Select <b>Authorized service providers</b>.</li></ol>

**Table 4-3** Support information locations (continued)

Service consideration	Path to access information
Component and diagnosis information, failure detection, and required action	To locate diagnosis information and actions: <ol style="list-style-type: none"><li data-bbox="679 310 1182 338">1. Go to <a href="http://www.hp.com/go/techcenter/pcdiags">http://www.hp.com/go/techcenter/pcdiags</a>.</li><li data-bbox="679 359 911 386">2. Select <b>Get Support</b>.</li><li data-bbox="679 407 1422 457">3. Near the bottom of the window, select <b>Notebook PCs</b>, and then select your location.</li></ol>

---

## 5 Removal and replacement procedures for authorized service provider parts

This chapter provides removal and replacement procedures for authorized service provider parts.

---

 **IMPORTANT:** Only an authorized service provider should access the components described in this chapter. Accessing these parts can damage the computer or void the warranty.

 **NOTE:** Details about your computer, including model, serial number, product key, and length of warranty, are on the service tag at the bottom of your computer.

---

# Component replacement procedures

To remove and replace computer components, use the procedures described in this section.

 **NOTE:** HP continually improves and changes product parts. For complete and current information about supported parts for your computer, go to <https://partsurfer.hp.com/partsurfer/>, select your country or region, and then follow the on-screen instructions.

Make special note of each screw size and location during removal and replacement.

## Preparation for disassembly

To remove and replace computer components, use these procedures:

For initial safety procedures, see [Removal and replacement procedures preliminary requirements on page 33](#).

1. Turn off the computer. If you are unsure whether the computer is off or in Hibernation, turn the computer on, and then shut it down through the operating system.
2. Disconnect the power from the computer by unplugging the power cord from the computer.
3. Disconnect all external devices from the computer.

## Bottom cover

To remove the bottom cover, use this procedure and illustration.

**Table 5-1 Bottom cover descriptions and part numbers**

Description	Spare part number
For use only on computer models equipped with WWAN capability	N98094-001
For use only on computer models not equipped with WWAN capability	N98093-001

Before removing the bottom cover, prepare the computer for disassembly (see [Preparation for disassembly on page 44](#)).

Remove the bottom cover:

1. Close the computer and rest it upside down on a flat work surface with the front toward you.

2. Loosen the four Phillips captive screws that secure the bottom cover to the computer.

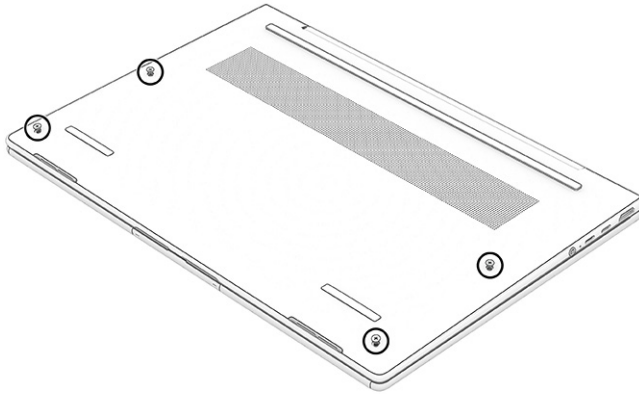

3. Insert a thin plastic tool (1) into the speaker grate on the bottom of the computer, and then lift the tool to release the bottom cover (2).
4. Lift the bottom cover (3) off the computer.

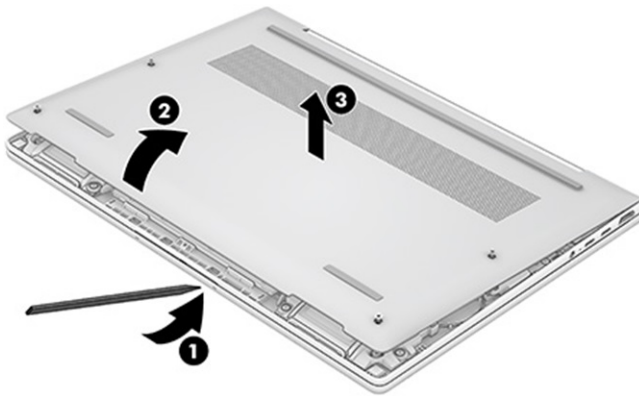

To replace the bottom cover, reverse the removal procedures.

## Battery

To remove the battery, use this procedure and illustration.

**Table 5-2** Battery descriptions and part numbers

Description	Spare part number
6 cell, 68 Whr, Li-ion battery	N59788-005

**Table 5-2 Battery descriptions and part numbers (continued)**

Description	Spare part number
3 cell, 56 Whr, Li-ion battery	P05235-001

 **WARNING!** To avoid personal injury and damage to the product:

- Do *not* puncture, twist, or crack the battery.
- Do *not* cause an external puncture or rupture to the battery. They can cause a short inside the battery, which can result in battery thermal runaway.
- Do *not* handle or touch the battery enclosure with sharp objects such as tweezers or pliers, which might puncture the battery.
- Do *not* compress or squeeze the battery case with tools or heavy objects stacked on top of the case. These actions can apply undue force on the battery.
- Do *not* touch the connectors with any metallic surface or object, such as metal tools, screws, or coins, which can cause shorting across the connectors.

Before removing the battery, follow these steps:

1. Prepare the computer for disassembly (see [Preparation for disassembly on page 44](#)).
2. Remove the bottom cover (see [Bottom cover on page 44](#)).

 **WARNING!** To reduce potential safety issues, use only the user-replaceable battery provided with the computer, a replacement battery provided by HP, or a compatible battery purchased from HP.

 **IMPORTANT:** Removing a battery that is the sole power source for the computer can cause loss of information. To prevent loss of information, save your work or shut down the computer through Windows before you remove the battery.

Remove the battery:

1. Disconnect the battery cable **(1)** from the system board.
2. Swing the battery latches **(2)** toward the inside of the computer.

- Lift the front edge of the battery (3) until it rests at an angle, and then remove the battery (4) from the computer.

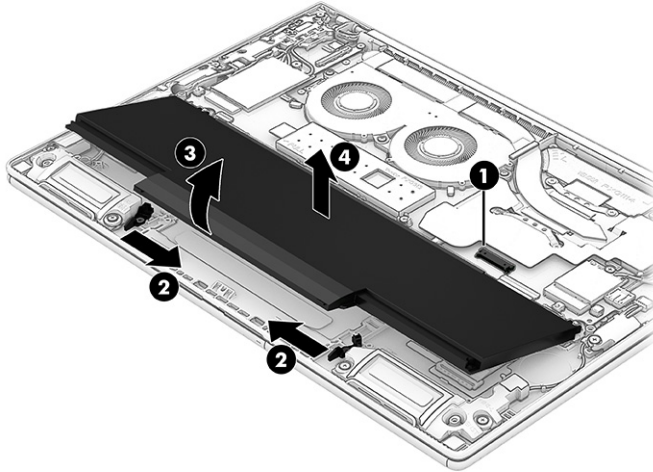

To install the battery, reverse the removal procedures.

**NOTE:** When replacing the battery, be sure to completely reassemble the computer and plug in the AC adapter before turning the computer on.

## WWAN module

To remove the WWAN module, use this procedure and illustration.

**Table 5-3 WWAN module description and part number**

Description	Spare part number
Qualcomm 9205 LTE-M (CAT-M1 fSVC)	N90688-001

**IMPORTANT:** To prevent an unresponsive system, replace the wireless module only with a wireless module authorized for use in the computer by the governmental agency that regulates wireless devices in your country or region. If you replace the module and then receive a warning message, remove the module to restore device functionality, and then contact technical support.

Before removing the WWAN module, follow these steps:

- Prepare the computer for disassembly (see [Preparation for disassembly on page 44](#)).
- Remove the bottom cover (see [Bottom cover on page 44](#)).
- Disconnect the battery cable from the computer (see [Battery on page 45](#)).

Remove the WWAN module:

- Carefully disconnect the two WWAN antenna cables (1) from the terminals on the WWAN module.  
The #5 WWAN antenna cable connects to the WWAN module #5 Main terminal. The #6 WWAN antenna cable connects to the WWAN module #6 Aux terminal.
- Remove the Phillips M2.0 × 2.4 screw (2) that secures the WWAN module to the system board.

3. Lift the edge of the WWAN module (3) opposite until it rests at an angle.
4. Remove the WWAN module (4) by pulling the module away from the slot at an angle.

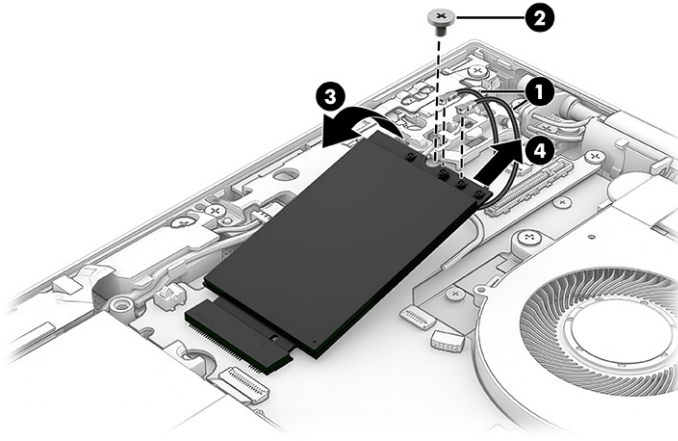

5. If the WWAN antenna is not connected to the terminal on the WWAN module, install a protective sleeve on the antenna connector, as shown in the following illustration.

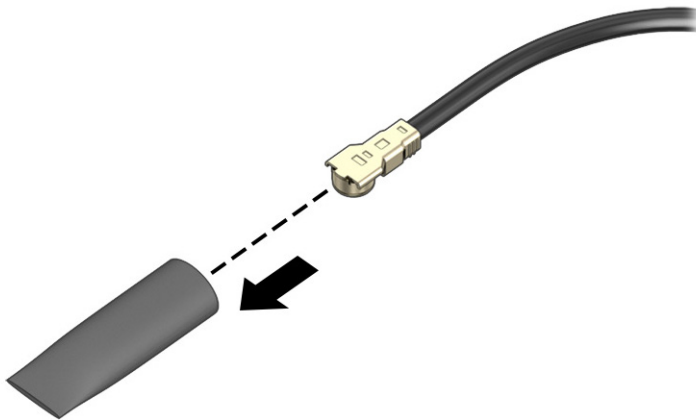

To replace the WWAN module, reverse the removal procedures.

 **NOTE:** The WWAN module is designed with a notch to prevent incorrect insertion.

## Solid-state drive

To remove the SSD, use this procedure and illustration.

**Table 5-4 SSD descriptions and part numbers**

Description	Spare part number
For use in all countries and regions except the People's Republic of China	
2 TB, M.2 2280, PCIe-4×4, ZTurbo SSD with TLC	M52027-001
1 TB, 2280, PCIe-4×4, NVMe, SSD with TLC	M16560-001
1 TB, M.2 2280, PCIe-4×4, NVMe, value SSD	N45474-001
512 GB, M.2 2280, PCIe-4×4, NVMe, SSD	N45476-001

**Table 5-4 SSD descriptions and part numbers (continued)**

Description	Spare part number
512 GB, 2280, PCIe-4×4, NVMe, SSD with TLC	M17436-001
512 GB, M.2 2280, PCIe-4×4, SSD with SED and TLC	M52031-001
256 GB, M.2 2280, PCIe-4×4, NVMe, SSD	N45477-001
256 GB, M.2 2280, PCIe-4×4, NVMe, SSD with SED and TLC	N35225-001
For use only in the People's Republic of China	
2 TB, 2280, PCIe-4×4, NVMe SSD with TLC	N77396-001
1 TB, 2280, PCIe-4×4, NVMe, SSD with TLC	N77395-001
1 TB, 2280, PCIe-4×4, NVMe, value SSD	N77394-001
512 GB, 2280, PCIe-4×4, NVMe, SSD with TLC	N77393-001
512 GB, 2280, PCIe-4×4, NVMe, value SSD	N77392-001
256 GB, 2280, PCIe-4×4, NVMe, value SSD	N77391-001
SSD bracket included in the Bracket Kit, spare part number N98115-001	

Before removing the SSD, follow these steps:

1. Prepare the computer for disassembly (see [Preparation for disassembly on page 44](#)).
2. Remove the bottom cover (see [Bottom cover on page 44](#)).
3. Disconnect the battery cable from the computer (see [Battery on page 45](#)).

Remove the SSD:

1. Remove the Phillips M2.0 × 2.4 screw **(1)** that secures the SSD to the computer.
2. Lift the edge of the SSD **(2)** opposite the slot until it rests at an angle.
3. Remove the SSD **(3)** by pulling the drive away from the slot at an angle.

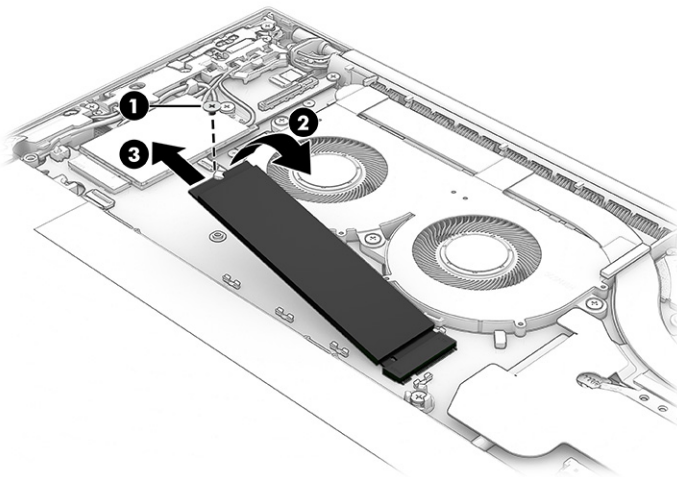

4. Thoroughly clean the thermal material from the surfaces of the SSD (1) and the system board (2) each time you remove the SSD. Replacement SSD thermal material is included in the SSD spare part kit. The following illustration shows the replacement thermal material locations.

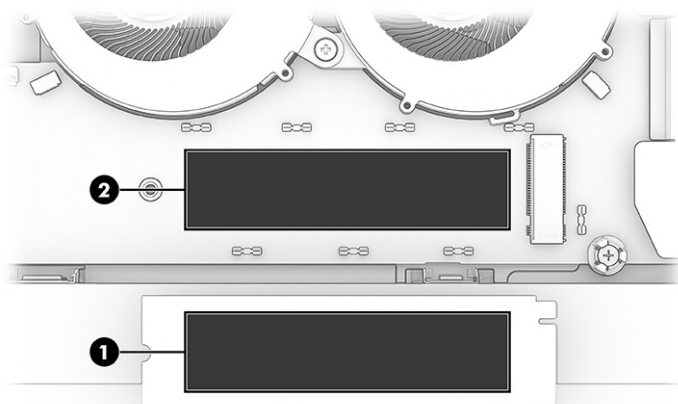

To replace the SSD, reverse the removal procedures.

 **NOTE:** The SSD is designed with a notch to prevent incorrect insertion.

## WLAN module

To remove the WLAN module, use this procedure and illustration.

**Table 5-5 WLAN module descriptions and part numbers**

Description	Spare part number
Intel AX211 Wi-Fi 6E + Bluetooth 5.3 M.2 2230 vPro 160 MHz CNVi WW WLAN module	M53363-001
Intel AX211 Wi-Fi 6E + Bluetooth 5.3 M.2 2230 non-vPro 160 MHz CNVi WW WLAN module	M53366-001
Intel BE200 M.2 2230 Wi-Fi 7 + Bluetooth 5.4 vPro WW WLAN module	N39882-00
Intel BE200 M.2 2230 Wi-Fi 7 + Bluetooth 5.4 non-vPro WW WLAN module	N39883-001

 **IMPORTANT:** To prevent an unresponsive system, replace the wireless module only with a wireless module authorized for use in the computer by the governmental agency that regulates wireless devices in your country or region. If you replace the module and then receive a warning message, remove the module to restore device functionality, and then contact technical support.

Before removing the WLAN module, follow these steps:

1. Prepare the computer for disassembly (see [Preparation for disassembly on page 44](#)).
2. Remove the bottom cover (see [Bottom cover on page 44](#)).
3. Disconnect the battery cable from the computer (see [Battery on page 45](#)).

Remove the WLAN module:

1. Carefully disconnect the two WLAN antenna cables (1) from the terminals on the WLAN module.  
  
Computer models have either one or two WLAN antennas. On models with two antennas, the #1 WLAN antenna cable connects to the WLAN module #1 Main terminal. The #2 WLAN antenna cable connects to the WLAN module #2 Aux terminal.
2. Remove the Phillips M2.0 × 2.4 screw (2) that secures the WLAN module to the system board.
3. Lift the edge of the WLAN module (3) opposite until it rests at an angle.
4. Remove the WLAN module (4) by pulling the module away from the slot at an angle.

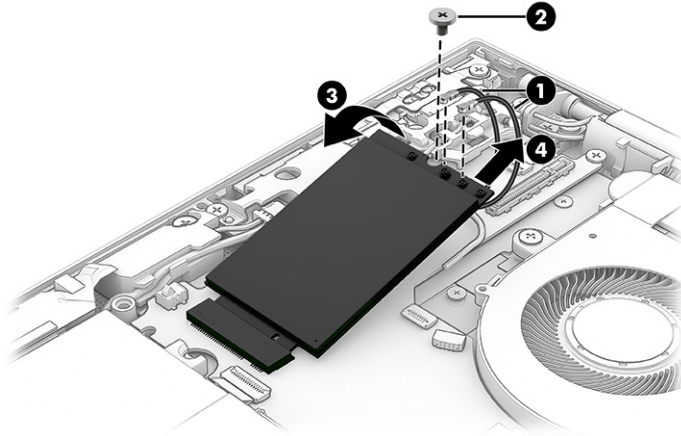

5. If the WLAN antenna is not connected to the terminal on the WLAN module, install a protective sleeve on the antenna connector, as shown in the following illustration.

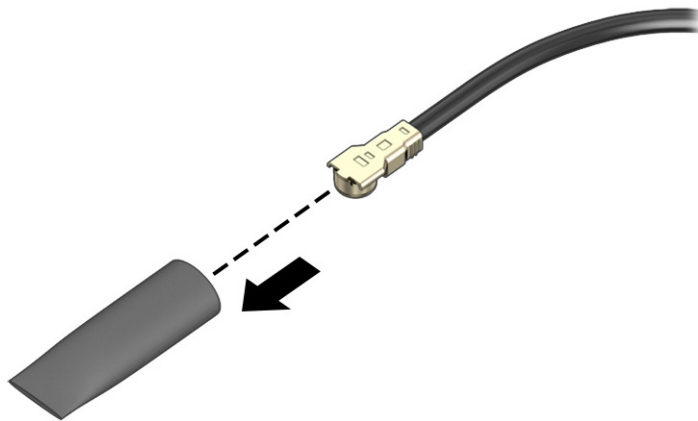

To replace the WLAN module, reverse the removal procedures.

 **NOTE:** The WLAN module is designed with a notch to prevent incorrect insertion.

## System board

To remove the system board, use these procedures and illustrations.

**Table 5-6 System board descriptions and part numbers**

Description	Spare part number
<b>System board</b> (includes processor): All system boards use the following part numbers:	
xxxxxx-001: Non-Windows operating system	
xxxxxx-601: Windows 10 operating system	
For use in all countries and regions except the People's Republic of China	
Equipped with an Intel Core U7-165H processor, 32 GB of system memory, OSR, TIPD, and the Windows 11 operating system	N97665-601
Equipped with an Intel Core U7-165H processor, 32 GB of system memory, OSR, TIPD, and a non-Windows operating system	N97665-001
Equipped with an Intel Core U7-165H processor, 32 GB of system memory, TIPD, and the Windows 11 operating system	N97660-601
Equipped with an Intel Core U7-165H processor, 32 GB of system memory, TIPD, and a non-Windows operating system	N97660-001
Equipped with an Intel Core U7-165H processor, 16 GB of system memory, OSR, TIPD, and the Windows 11 operating system	N97664-601
Equipped with an Intel Core U7-165H processor, 16 GB of system memory, OSR, TIPD, and a non-Windows operating system	N97664-001
Equipped with an Intel Core U7-165H processor, 16 GB of system memory, TIPD, and the Windows 11 operating system	N97659-601
Equipped with an Intel Core U7-165H processor, 16 GB of system memory, TIPD, and a non-Windows operating system	N97659-001
Equipped with an Intel Core U7-155H processor, 32 GB of system memory, TIPD, and the Windows 11 operating system	N97658-601
Equipped with an Intel Core U7-155H processor, 32 GB of system memory, TIPD, and a non-Windows operating system	N97658-001
Equipped with an Intel Core U7-155H processor, 16 GB of system memory, TIPD, and the Windows 11 operating system	N97657-601
Equipped with an Intel Core U7-155H processor, 16 GB of system memory, TIPD, and a non-Windows operating system	N97657-001
Equipped with an Intel Core U5-135H processor, 32 GB of system memory, OSR, TIPD, and the Windows 11 operating system	N97663-601
Equipped with an Intel Core U5-135H processor, 32 GB of system memory, OSR, TIPD, and a non-Windows operating system	N97663-001
Equipped with an Intel Core U5-135H processor, 32 GB of system memory, TIPD, and the Windows 11 operating system	N97656-601
Equipped with an Intel Core U5-135H processor, 32 GB of system memory, TIPD, and a non-Windows operating system	N97656-001
Equipped with an Intel Core U5-135H processor, 16 GB of system memory, OSR, TIPD, and the Windows 11 operating system	N97662-601
Equipped with an Intel Core U5-135H processor, 16 GB of system memory, OSR, TIPD, and a non-Windows operating system	N97662-001
Equipped with an Intel Core U5-135H processor, 16 GB of system memory, TIPD, and the Windows 11 operating system	N97655-601

**Table 5-6 System board descriptions and part numbers (continued)**

<b>Description</b>	<b>Spare part number</b>
Equipped with an Intel Core U5-135H processor, 16 GB of system memory, TIPD, and a non-Windows operating system	N97655-001
Equipped with an Intel Core U5-135U processor, 16 GB of system memory, TIPD, and the Windows 11 operating system	N97654-601
Equipped with an Intel Core U5-135U processor, 16 GB of system memory, TIPD, and a non-Windows operating system	N97654-001
Equipped with an Intel Core U5-125H processor, 32 GB of system memory, TIPD, and the Windows 11 operating system	N97653-601
Equipped with an Intel Core U5-125H processor, 32 GB of system memory, TIPD, and a non-Windows operating system	N97653-001
Equipped with an Intel Core U5-125H processor, 16 GB of system memory, OSR, TIPD, and the Windows 11 operating system	N97661-601
Equipped with an Intel Core U5-125H processor, 16 GB of system memory, OSR, TIPD, and a non-Windows operating system	N97661-001
Equipped with an Intel Core U5-125H processor, 16 GB of system memory, TIPD, and the Windows 11 operating system	N97652-601
Equipped with an Intel Core U5-125H processor, 16 GB of system memory, TIPD, and a non-Windows operating system	N97652-001
For use only in the People's Republic of China	
Equipped with an Intel Core U7-165H processor, 32 GB of system memory, TIPD, and the Windows 11 operating system	N97674-601
Equipped with an Intel Core U7-165H processor, 32 GB of system memory, TIPD, and a non-Windows operating system	N97674-001
Equipped with an Intel Core U7-165H processor, 16 GB of system memory, TIPD, and the Windows 11 operating system	N97673-601
Equipped with an Intel Core U7-165H processor, 16 GB of system memory, TIPD, and a non-Windows operating system	N97673-001
Equipped with an Intel Core U7-155H processor, 32 GB of system memory, TIPD, and the Windows 11 operating system	N97672-601
Equipped with an Intel Core U7-155H processor, 32 GB of system memory, TIPD, and a non-Windows operating system	N97672-001
Equipped with an Intel Core U7-155H processor, 16 GB of system memory, TIPD, and the Windows 11 operating system	N97671-601
Equipped with an Intel Core U7-155H processor, 16 GB of system memory, TIPD, and a non-Windows operating system	N97671-001
Equipped with an Intel Core U5-135H processor, 32 GB of system memory, TIPD, and the Windows 11 operating system	N97670-601
Equipped with an Intel Core U5-135H processor, 32 GB of system memory, TIPD, and a non-Windows operating system	N97670-001
Equipped with an Intel Core U5-135H processor, 16 GB of system memory, TIPD, and the Windows 11 operating system	N97669-601
Equipped with an Intel Core U5-135H processor, 16 GB of system memory, TIPD, and a non-Windows operating system	N97669-001

**Table 5-6 System board descriptions and part numbers (continued)**

Description	Spare part number
Equipped with an Intel Core U5-135U processor, 16 GB of system memory, TIPD, and the Windows 11 operating system	N97666-601
Equipped with an Intel Core U5-135U processor, 16 GB of system memory, TIPD, and a non-Windows operating system	N97666-001

Before removing the system board, follow these steps:

1. Prepare the computer for disassembly (see [Preparation for disassembly on page 44](#)).
2. Remove the bottom cover (see [Bottom cover on page 44](#)).
3. Disconnect the battery cable from the computer (see [Battery on page 45](#)).

When you replace the system board, be sure to remove the following components (as applicable) from the defective system board and install them on the replacement system board:

- Solid-state drive (see [Solid-state drive on page 48](#)).
- WLAN module (see [WLAN module on page 50](#)).
- Fan/heat sink assembly (see [Fan/heat sink assembly on page 56](#)).

Remove the system board:

1. Release the zero insertion force (ZIF) connector **(1)** the fingerprint reader cable is connected to, and then disconnect the fingerprint reader cable from the system board.
2. Disconnect the display hub cable **(2)** from the system board.
3. Release the ZIF connector **(3)** the keyboard backlight cable is connected to, and then disconnect the keyboard backlight cable from the system board.
4. Disconnect the display panel cable **(4)** from the system board.
5. Disconnect the speaker cables **(5)** from the system board.
6. Carefully disconnect the two WLAN antenna cables **(6)** from the terminals on the WLAN module.



**NOTE:** Computer models have either one or two WLAN antennas. On models with two antennas, the #1 WLAN antenna cable connects to the WLAN module #1 Main terminal. The #2 WLAN antenna cable connects to the WLAN module #2 Aux terminal.

7. Release the ZIF connector **(7)** the transfer board cable is connected to, and then disconnect the transfer board cable from the system board.
8. Release the ZIF connector **(8)** the NFC module cable is connected to, and then disconnect the NFC module cable from the system board.
9. Carefully disconnect the two WWAN antenna cables **(9)** from the terminals on the WWAN module.



**NOTE:** Computer models have two WWAN antennas. The #5 WWAN antenna cable connects to the WWAN module #5 Main terminal. The #6 WWAN antenna cable connects to the WWAN module #6 Aux terminal.

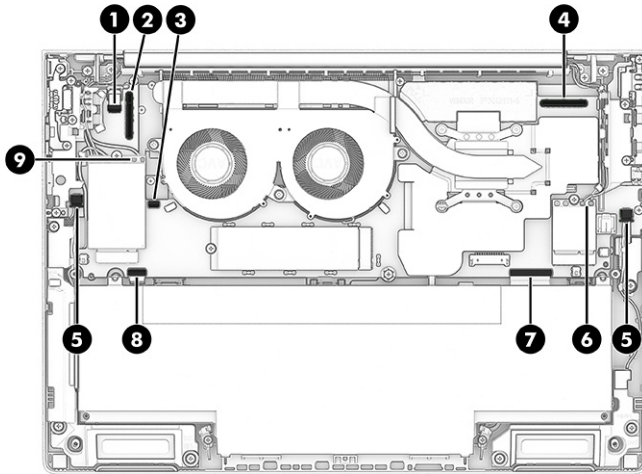

10. Remove the twelve Phillips M2.0 × 4.9 screws (1) that secure the system board, the left and right I/O bracket holders, the left and right I/O brackets, the middle hook holder, and the security bracket to the computer.
11. Loosen the Phillip captive screw (2) that secures the system board and fan/heat sink assembly to the computer.
12. Remove the middle hook holder (3), the left and right I/O brackets (4), the left and right I/O bracket holders (5), and the security bracket (6).

The system board hardware components are available as detailed below:

- Middle hook holder: Included in the Plastics Kit, spare part number N98117-001
- Left and right I/O brackets: Included in the Bracket Kit, spare part number N98115-001
- Left and right I/O bracket holders: Included in the Plastics Kit, spare part number N98117-001
- Security bracket: Not available as a spare part

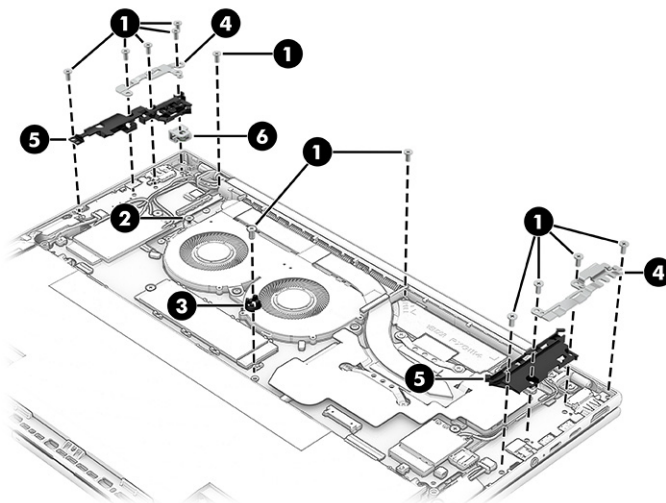

13. Lift the right side of the system board (1) until it rests at an angle, and then remove the system board (2) by sliding it up and to the right at an angle.

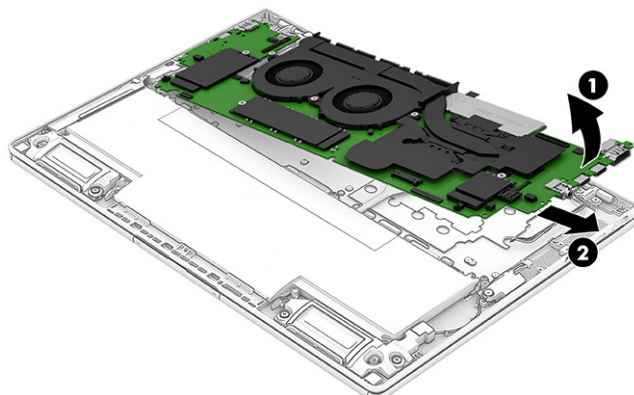

To install the system board, reverse the removal procedures.

## Fan/heat sink assembly

To remove the fan/heat sink assembly, use these procedures and illustrations.

**Table 5-7** Fan/heat sink assembly description and part number

Description	Spare part number
Fan/heat sink assembly (includes captive screws and replacement thermal material)	N98097-001

Before removing the fan/heat sink assembly, follow these steps:

1. Prepare the computer for disassembly (see [Preparation for disassembly on page 44](#)).
2. Remove the bottom cover (see [Bottom cover on page 44](#)).
3. Disconnect the battery cable from the computer (see [Battery on page 45](#)).
4. Remove the system board (see [System board on page 51](#)).

Remove the fan/heat sink assembly:

1. Disconnect the fan cables (1) from the system board.
2. Loosen the seven screws (2) and (3) that secure the fan/heat sink assembly to the system board.

3. Remove the fan/heat sink assembly **(4)** from the system board.

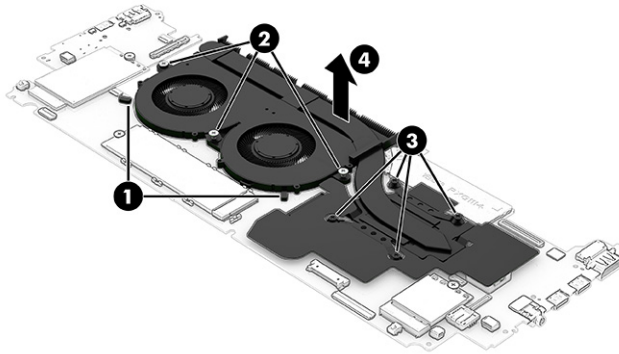

4. Thoroughly clean the thermal material from the surfaces of the fan/heat sink assembly and the system board components each time you remove the fan/heat sink assembly. Replacement thermal material is included with the fan/heat sink assembly and system board spare part kits. The following illustration shows the replacement thermal material locations.

Thermal paste is used on the processor **(1)** and on the fan/heat sink assembly area **(2)** that services the processor.

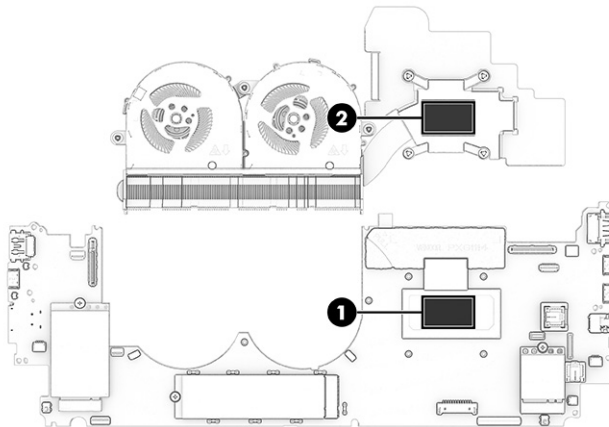

To replace the fan/heat sink assembly, reverse the removal procedures.

## Fingerprint reader cable

To remove the fingerprint reader cable, use this procedure and illustration.

The fingerprint reader cable is included in the Cable Kit, spare part number N98116-001.

Before removing the fingerprint reader cable, follow these steps:

1. Prepare the computer for disassembly (see [Preparation for disassembly on page 44](#)).
2. Remove the bottom cover (see [Bottom cover on page 44](#)).
3. Disconnect the battery cable from the computer (see [Battery on page 45](#)).
4. Remove the system board (see [System board on page 51](#)).

Remove the fingerprint reader cable:

1. Release the ZIF connector **(1)** the fingerprint reader cable is connected to, and then disconnect the fingerprint reader cable from the fingerprint reader.
2. Remove the fingerprint reader cable **(2)** from the computer.

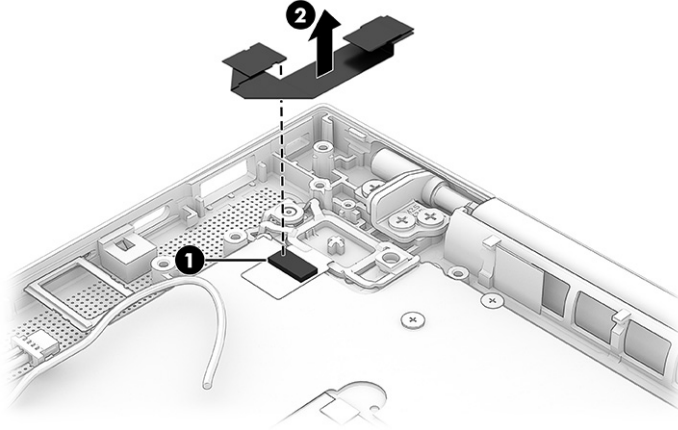

To replace the fingerprint reader cable, reverse the removal procedures.

## Fingerprint reader

To remove the fingerprint reader, use this procedure and illustration.

**Table 5-8** Fingerprint reader description and spare part number

Description	Spare part number
Fingerprint reader (includes cable)	N98113-001
<b>NOTE:</b> The fingerprint reader spare part kit does not include the fingerprint reader cable. The fingerprint reader cable is included in the Cable Kit, spare part number N98116-001.	
Power button without fingerprint reader	N98114-001

Before removing the fingerprint reader, follow these steps:

1. Prepare the computer for disassembly (see [Preparation for disassembly on page 44](#)).
2. Remove the bottom cover (see [Bottom cover on page 44](#)).
3. Disconnect the battery cable from the computer (see [Battery on page 45](#)).
4. Remove the system board (see [System board on page 51](#)).
5. Remove the fingerprint reader cable (see [Fingerprint reader cable on page 57](#)).

Remove the fingerprint reader:

1. Remove the two Phillips M1.5 × 2.9 screws **(1)** that secure the fingerprint reader and bracket to the computer.
2. Detach the fingerprint reader **(2)** from the computer. The fingerprint reader is attached to the computer with double-sided adhesive.

- Remove the fingerprint reader bracket (3) and fingerprint reader (4) from the computer.

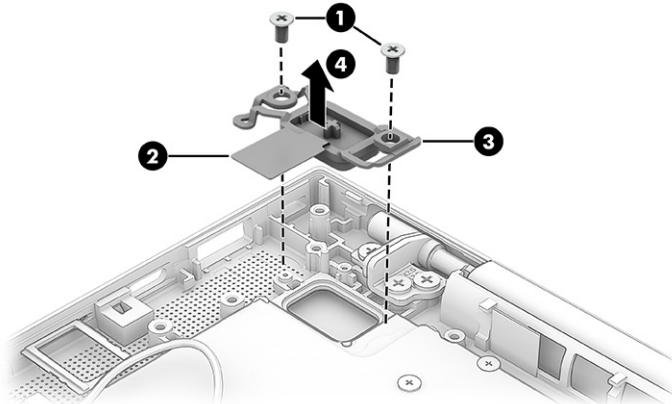

To replace the fingerprint reader, reverse the removal procedures.

## Display assembly

To remove and disassemble the display assembly, use these procedures and illustrations.

**Table 5-9 Display assembly descriptions and part numbers**

Description	Spare part number
35.6 cm (14.0 in), brightview, UWVA, OLED + LBL, with infrared webcam, for use on computer models equipped with WLAN; typical brightness: 400 nits	N98092-001
35.6 cm (14.0 in), brightview, UWVA, LBL, WUXGA, with infrared webcam, for use on computer models equipped with WWAN; typical brightness: 400 nits	N98091-001
35.6 cm (14.0 in), brightview, UWVA, LBL, WUXGA, with infrared webcam, for use on computer models equipped with WLAN; typical brightness: 400 nits	N98090-001
35.6 cm (14.0 in), brightview, UWVA, WUXGA, with TOF infrared webcam, for use on computer models equipped with WWAN and privacy filter; typical brightness: 1000 nits	N98089-001
35.6 cm (14.0 in), brightview, UWVA, WUXGA, with TOF infrared webcam, for use on computer models equipped with WLAN and privacy filter; typical brightness: 1000 nits	N98088-001
35.6 cm (14.0 in), brightview, UWVA, WUXGA, with TOF infrared webcam, for use on computer models equipped with WWAN and privacy filter; typical brightness: 800 nits	P04255-001
35.6 cm (14.0 in), brightview, UWVA, WUXGA, with TOF infrared webcam, for use on computer models equipped with WLAN and privacy filter; typical brightness: 800 nits	P04254-001
35.6 cm (14.0 in), antiglare, UWVA, LBL, WUXGA, with infrared webcam, for use on computer models equipped with WWAN; typical brightness: 400 nits	N98087-001
35.6 cm (14.0 in), antiglare, UWVA, LBL, WUXGA, with infrared webcam, for use on computer models equipped with WLAN; typical brightness: 400 nits	N98086-001
35.6 cm (14.0 in), antiglare, UWVA, WUXGA, with TOF infrared webcam, for use on computer models equipped with WWAN and privacy filter; typical brightness: 1000 nits	P04253-001
35.6 cm (14.0 in), antiglare, UWVA, WUXGA, with TOF infrared webcam, for use on computer models equipped with WLAN and privacy filter; typical brightness: 1000 nits	P04252-001
35.6 cm (14.0 in), antiglare, UWVA, WUXGA, with TOF infrared webcam, for use on computer models equipped with WWAN and privacy filter; typical brightness: 800 nits	N98085-001

**Table 5-9 Display assembly descriptions and part numbers (continued)**

Description	Spare part number
35.6 cm (14.0 in), antiglare, UWVA, WUXGA, with TOF infrared webcam, for use on computer models equipped with WLAN and privacy filter; typical brightness: 800 nits	N98084-001

Before removing the display assembly, follow these steps:

1. Prepare the computer for disassembly (see [Preparation for disassembly on page 44](#)).
2. Remove the bottom cover (see [Bottom cover on page 44](#)).
3. Disconnect the battery cable from the computer (see [Battery on page 45](#)).

Remove the display assembly:

1. Disconnect the display hub cable **(1)** from the system board.
2. Carefully disconnect the two WWAN antenna cables **(2)** from the terminals on the WWAN module.

The #5 WWAN antenna cable connects to the WWAN module #5 Main terminal. The #6 WWAN antenna cable connects to the WWAN module #6 Aux terminal.

3. Release the WWAN antenna cables from the retention clips **(3)** and routing channels that are built into the right I/O bracket holder.

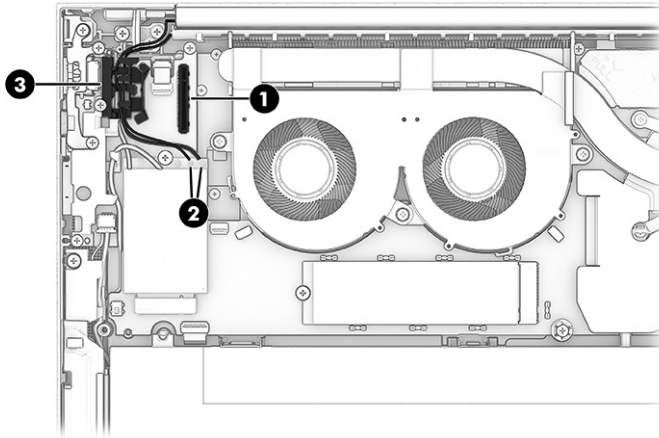

4. Disconnect the display panel cable **(1)** from the system board.
5. Carefully disconnect the two WLAN antenna cables **(2)** from the terminals on the WLAN module.

The #1 WLAN antenna cable connects to the WLAN module #1 Main terminal. The #2 WLAN antenna cable connects to the WLAN module #2 Aux terminal.

6. Release the WLAN antenna cables from the retention clips **(3)** and routing channels that are built into the left I/O bracket holder.

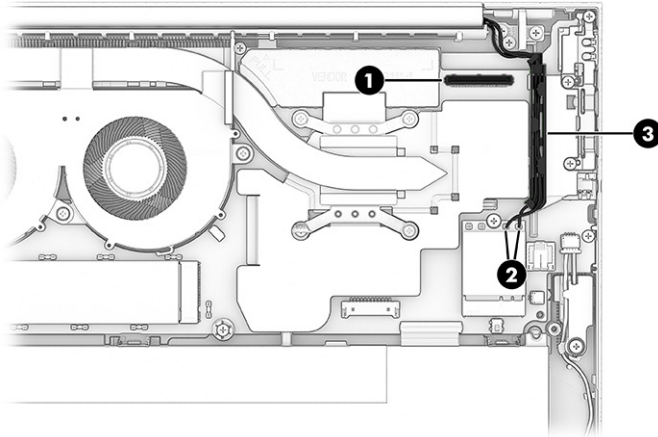

7. Remove the six Phillips M2.5 × 4.1 screws that secure the display assembly to the computer.

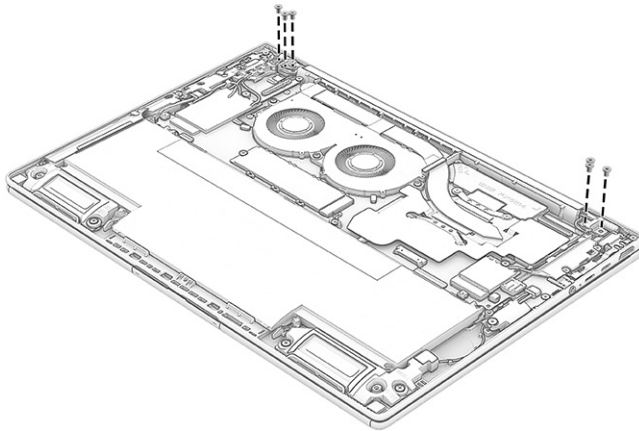

8. Swing the top edge of the display assembly **(1)** down and away from the top cover with keyboard until it rests at a 90-degree angle.
9. Release the display hinges from the top cover by sliding the top cover with keyboard **(2)** away from the display assembly.

10. Separate the top cover with keyboard (3) from the display assembly.

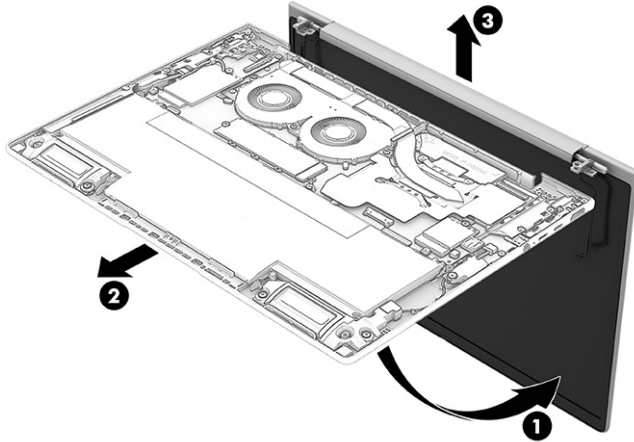

To replace the display assembly, reverse the removal procedures.

## Speakers

To remove the speakers, use this procedure and illustration.

**Table 5-10** Speaker description and part number

Description	Spare part number
Speakers (includes left and right speakers, cables, and six rubber isolators)	N98096-001

Before removing the speakers, follow these steps:

1. Prepare the computer for disassembly (see [Preparation for disassembly on page 44](#)).
2. Remove the bottom cover (see [Bottom cover on page 44](#)).
3. Remove the battery from the computer (see [Battery on page 45](#)).

Remove the speakers:

1. Disconnect the speaker cables (1) from the system board.
2. Remove the six Phillips M2.0 × 2.4 broadhead screws (2) that secure the speakers to the computer.
3. Release the speaker cables from the retention clips (3) that are built into the computer.
4. Remove the rear speakers (4) from the computer.
5. Remove the front speakers (5) from the computer.



**NOTE:** When removing the speakers, make note of the location of the rubber isolator locations (6). The absence of or damage to these isolators can result in degraded speaker performance.

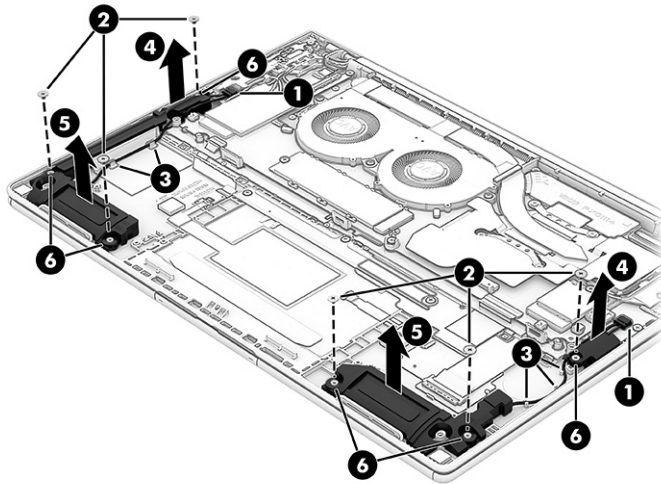

To replace the speakers, reverse the removal procedures.

## NFC module cable

To remove the NFC module cable, use this procedure and illustration.

The NFC module cable is included in the Cable Kit, spare part number N98116-001.

Before removing the NFC module cable, follow these steps:

1. Prepare the computer for disassembly (see [Preparation for disassembly on page 44](#)).
2. Remove the bottom cover (see [Bottom cover on page 44](#)).
3. Remove the battery from the computer (see [Battery on page 45](#)).

Remove the NFC module cable:

1. Release the ZIF connector **(1)** the NFC module cable is connected to, and then disconnect the NFC module cable from the system board.
2. Release the ZIF connector **(2)** the NFC module cable is connected to, and then disconnect the NFC module cable from the NFC module.

3. Remove the NFC module cable (3) from the computer.

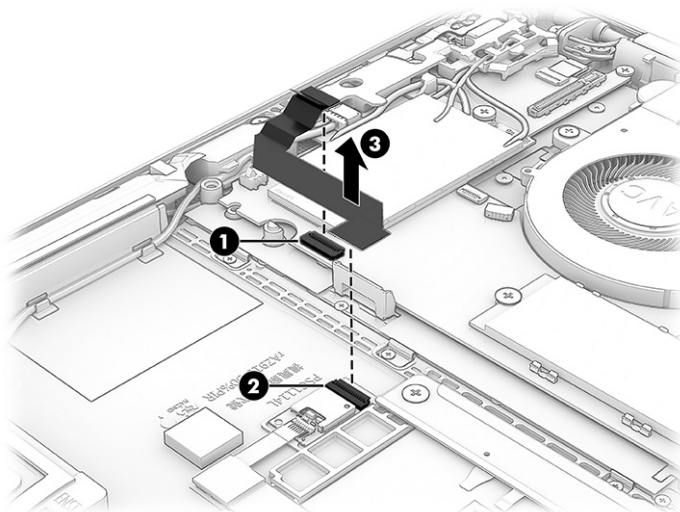

To replace the NFC module cable, reverse the removal procedures.

## NFC module

To remove the NFC module, use this procedure and illustration.

**Table 5-11 NFC module description and part number**

Description	Spare part number
NFC module	N08706-001

**NOTE:** The NFC module spare part kit does not include the NFC module. The NFC module cable is included in the Cable Kit, spare part number N98116-001.

Before removing the NFC module, follow these steps:

1. Prepare the computer for disassembly (see [Preparation for disassembly on page 44](#)).
2. Remove the bottom cover (see [Bottom cover on page 44](#)).
3. Remove the battery from the computer (see [Battery on page 45](#)).
4. Remove the NFC module cable (see [NFC module cable on page 63](#)).

Remove the NFC module:

1. Release the ZIF connector (1) the NFC module antenna cable is connected to, and then disconnect the NFC module antenna cable from the NFC module.

2. Detach the NFC module **(2)** from the computer. The NFC module is attached to the computer with double-sided adhesive.

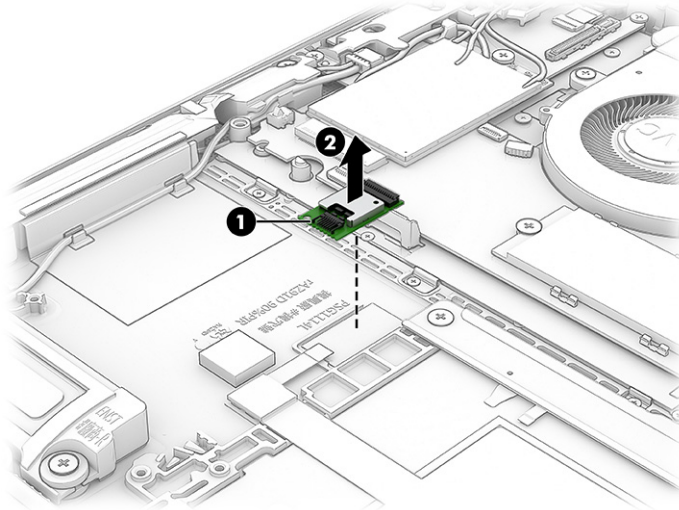

To replace the NFC module, reverse the removal procedures.

## Touchpad cable

To remove the touchpad cable, use this procedure and illustration.

The touchpad cable is included in the Cable Kit, spare part number N98116-001.

Before removing the touchpad cable, follow these steps:

1. Prepare the computer for disassembly (see [Preparation for disassembly on page 44](#)).
2. Remove the bottom cover (see [Bottom cover on page 44](#)).
3. Remove the battery from the computer (see [Battery on page 45](#)).

Remove the touchpad cable:

1. Release the ZIF connector **(1)** the touchpad cable is connected to, and then disconnect the touchpad cable from the transfer board.
2. Release the ZIF connector **(2)** the touchpad cable is connected to, and then disconnect the touchpad cable from the touchpad.

- Detach the touchpad cable (3) from the computer. The touchpad cable is attached to the computer with double-sided adhesive.

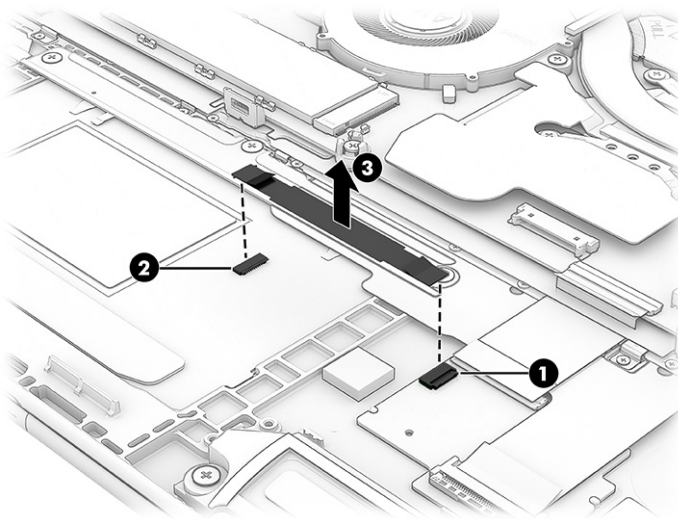

- Remove the touchpad cable.

To replace the touchpad cable, reverse the removal procedures.

## Touchpad

To remove the touchpad, use this procedure and illustration.

**Table 5-12** Touchpad descriptions and part numbers

Description	Spare part number
For use on computer models equipped with NFC (includes NFC module antenna and cable)	N98120-001
For use on computer models not equipped with NFC	N98119-001

**NOTE:** The touchpad spare part kit does not include the touchpad cable. The touchpad cable is included in the Cable Kit, spare part number N98116-001.

Before removing the touchpad, follow these steps:

- Prepare the computer for disassembly (see [Preparation for disassembly on page 44](#)).
- Remove the bottom cover (see [Bottom cover on page 44](#)).
- Remove the battery from the computer (see [Battery on page 45](#)).
- Remove the touchpad cable (see [Touchpad cable on page 65](#)).

Remove the touchpad:

- Release the ZIF connector (1) the NFC module antenna cable is connected to, and then disconnect the NFC module antenna cable from the NFC module.
- Remove the three Phillips M2.0 × 2.4 broadhead screws (2) that secure the touchpad to the computer.
- Lift the rear edge of the touchpad (3) until it rests at an angle.

4. Remove the touchpad **(4)** by sliding it up and back at an angle.

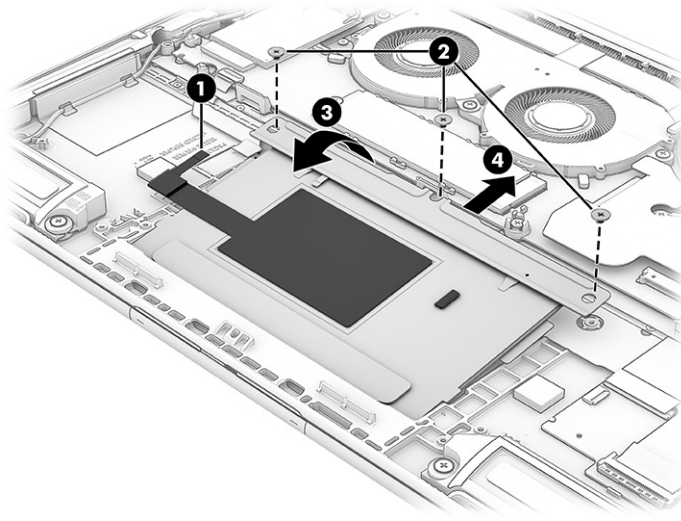

To replace the touchpad, reverse the removal procedures.

## Transfer board cable

To remove the transfer board cable, use this procedure and illustration.

The transfer board cable is included with the transfer board spare part kit, spare part number N98118-001.

Before removing the transfer board cable, follow these steps:

1. Prepare the computer for disassembly (see [Preparation for disassembly on page 44](#)).
2. Remove the bottom cover (see [Bottom cover on page 44](#)).
3. Remove the battery from the computer (see [Battery on page 45](#)).

Remove the transfer board cable:

1. Release the ZIF connector **(1)** the transfer board cable is connected to, and then disconnect the transfer board cable from the system board.
2. Release the ZIF connector **(2)** the transfer board cable is connected to, and then disconnect the transfer board cable from the transfer board.

3. Remove the transfer board cable **(3)** from the computer.

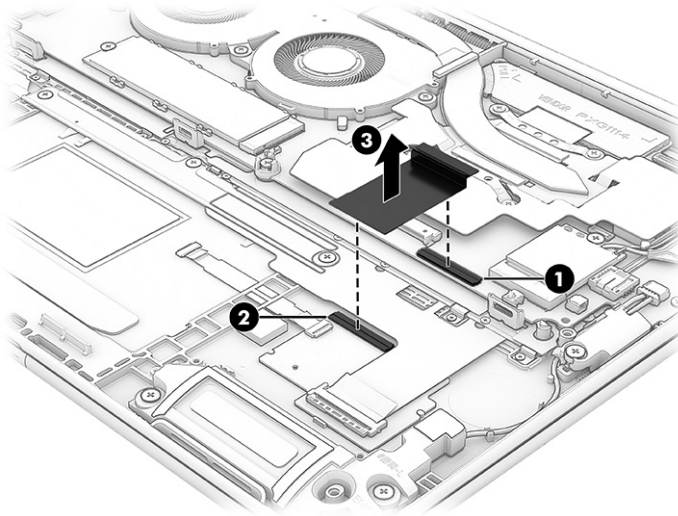

To replace the transfer board cable, reverse the removal procedures.

## Transfer board

To remove the transfer board, use this procedure and illustration.

**Table 5-13** Transfer board description and part number

Description	Spare part number
Transfer board (includes cable)	N98118-001

Before removing the transfer board, follow these steps:

1. Prepare the computer for disassembly (see [Preparation for disassembly on page 44](#)).
2. Remove the bottom cover (see [Bottom cover on page 44](#)).
3. Remove the battery from the computer (see [Battery on page 45](#)).
4. Remove the transfer board cable (see [Transfer board cable on page 67](#)).

Remove the transfer board:

1. Release the ZIF connector **(1)** the keyboard cable is connected to, and then disconnect the keyboard cable from the transfer board.
2. Release the ZIF connector **(2)** the touchpad cable is connected to, and then disconnect the touchpad cable from the transfer board.

- Detach the transfer board (3) from the computer. The transfer board is attached to the computer with double-sided adhesive.

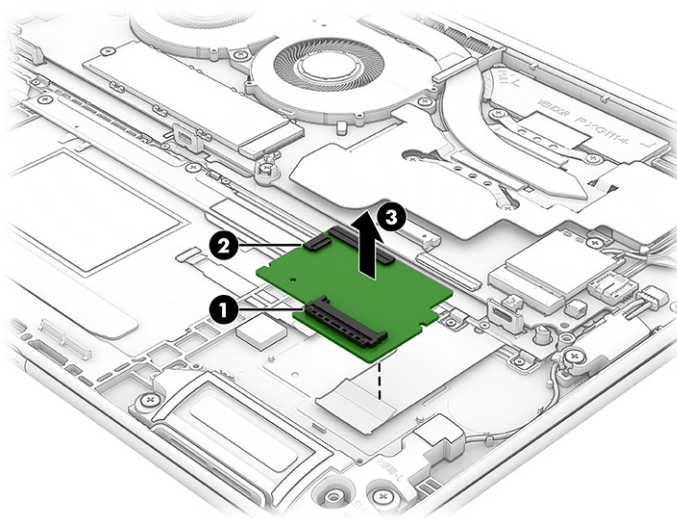

To replace the transfer board, reverse the removal procedures.

## Top cover with keyboard

The top cover with keyboard remains after removing all other spare parts from the computer. In this section, the first table provides the main spare part number for the top covers and keyboards. The second table provides the country codes.

**Table 5-14 Top cover with keyboard spare part numbers and descriptions**

Description	Spare part number
Top cover with keyboard with backlight and clickpad (includes backlight cable and keyboard cable)	N99343-xxx
Top cover with keyboard with clickpad (includes keyboard cable)	N99344-xxx

**Table 5-15 Spare part country codes**

For use in country or region	Spare part number	For use in country or region	Spare part number	For use in country or region	Spare part number
Belgium	-A41	Israel	-BB1	Slovenia	-BA1
Brazil	-201	Italy	-061	South Korea	-AD1
Bulgaria	-261	Japan	-291	Spain	-071
The Czech Republic and Slovakia	-FL1	Kazakhstan	-DF1	Sweden and Finland	-B71
Denmark	-081	Latin America	-161	Switzerland	-BG1
Denmark, Finland, and Norway	-DH1	The Netherlands	-B31	Taiwan	-AB1
France	-051	Northwest Africa	-FP1	Thailand	-281
French Canada	-DB1	Norway	-091	Turkey	-141
Germany	-041	Portugal	-131	Turkey-F	-541

**Table 5-15 Spare part country codes (continued)**

<b>For use in country or region</b>	<b>Spare part number</b>	<b>For use in country or region</b>	<b>Spare part number</b>	<b>For use in country or region</b>	<b>Spare part number</b>
Greece	-151	Romania	-271	Ukraine	-BD1
Hungary	-211	Russia	-251	United Kingdom	-031
Iceland	-DD1	Saudi Arabia	-171	United States	-001
India	-D61				

---

## 6 Computer Setup (BIOS), TPM, and HP Sure Start

HP provides several tools to help set up and protect your computer.

# Using Computer Setup

Computer Setup, or Basic Input/Output System (BIOS), controls communication between all the input and output devices on the system (such as hard drives, display, keyboard, mouse, and printer). Computer Setup includes settings for types of devices installed, the startup sequence of the computer, and amount of system and extended memory.

---

 **NOTE:** Use extreme care when making changes in Computer Setup. Errors can prevent the computer from operating properly.

---

To start Computer Setup, turn on or restart the computer, and when the HP logo appears, press **f10** to enter Computer Setup.

## Navigating and selecting in Computer Setup

You can navigate and select in Computer Setup using one or more methods.

- To select a menu or a menu item, use the **tab** key and the keyboard arrow keys and then press **enter**, or use a pointing device to select the item.
- To scroll up and down, select the up arrow or the down arrow in the upper-right corner of the screen, or use the up arrow key or the down arrow key on the keyboard.
- To close open dialog boxes and return to the main Computer Setup screen, press **esc**, and then follow the on-screen instructions.

To exit Computer Setup, choose one of the following methods:

- To exit Computer Setup menus without saving your changes, select **Main**, select **Ignore Changes and Exit**, and then select **Yes**.

---

 **NOTE:** If you are using arrow keys to highlight your choice, you must then press **enter**.

---

- To save your changes and exit Computer Setup menus, select **Main**, select **Save Changes and Exit**, and then select **Yes**.

---

 **NOTE:** If you are using arrow keys to highlight your choice, you must then press **enter**.

---

Your changes go into effect when the computer restarts.

## Restoring factory settings in Computer Setup

To return all settings in Computer Setup to the values that were set at the factory, follow these steps.

---

 **NOTE:** Restoring defaults will not change the hard drive mode.

---

1. Start Computer Setup. See [Using Computer Setup on page 72](#).
2. Select **Main**, select **Apply Factory Defaults and Exit**, and then select **Yes**.

---

 **NOTE:** If you are using arrow keys to highlight your choice, you must then press **enter**.

---

 **NOTE:** On select products, the selections might display **Restore Defaults** instead of **Apply Factory Defaults and Exit**.

---

Your changes go into effect when the computer restarts.

---

 **NOTE:** Your password settings and security settings are not changed when you restore the factory settings.

---

## Updating the BIOS

Updated versions of the BIOS might be available on the HP website. Most BIOS updates on the HP website are packaged in compressed files called *SoftPaqs*.

Some download packages contain a file named *Readme.txt*, which contains information regarding installing and troubleshooting the file.

## Determining the BIOS version

To decide whether you need to update Computer Setup (BIOS), first determine the BIOS version on your computer.

If you are already in Windows, you can access BIOS version information (also known as *ROM date* and *System BIOS*) by pressing **fn+esc** (select products only). Or you can use Computer Setup.

1. Start Computer Setup. See [Using Computer Setup on page 72](#).
2. Select **Main**, and then select **System Information**.
3. To exit Computer Setup menus without saving your changes, select **Main**, select **Ignore Changes and Exit**, and then select **Yes**.

---

 **NOTE:** If you are using arrow keys to highlight your choice, you must then press **enter**.

---

To check for later BIOS versions, see [Preparing for a BIOS update on page 73](#).

## Preparing for a BIOS update

Be sure to follow all prerequisites before downloading and installing a BIOS update.

 **IMPORTANT:** To reduce the risk of damage to the computer or an unsuccessful installation, download and install a BIOS update only when the computer is connected to reliable external power using the AC adapter. Do not download or install a BIOS update while the computer is running on battery power, docked in an optional docking device, or connected to an optional power source. During the download and installation, follow these instructions:

Do not disconnect power on the computer by unplugging the power cord from the AC outlet.

Do not shut down the computer or initiate Sleep.

Do not insert, remove, connect, or disconnect any device, cable, or cord.

---

## Downloading a BIOS update

After you review the prerequisites, you can check for and download BIOS updates.

1. Perform one of these tasks:
  - Select the **Search** icon in the taskbar, type `support` in the search box, and then select the **HP Support Assistant** app.
  - Select the question mark icon (select products only) in the taskbar.

2. Select **Updates**, and then select **Check for updates and messages**.
3. Follow the on-screen instructions.
4. At the download area, follow these steps:
  - a. Identify the most recent BIOS update and compare it to the BIOS version currently installed on your computer. Make a note of the date, name, or other identifier. You might need this information to locate the update later, after it has been downloaded to your hard drive.
  - b. Follow the on-screen instructions to download your selection to the hard drive.

Make a note of the path to the location on your hard drive where the BIOS update is downloaded. You will need to access this path when you are ready to install the update.



---

**NOTE:** If you connect your computer to a network, consult the network administrator before installing any software updates, especially system BIOS updates.

---

### Installing a BIOS update

BIOS installation procedures vary. Follow any instructions that are displayed on the screen after the download is complete. If no instructions are displayed, follow these steps.

1. Select the **Search** icon in the taskbar, type `file` in the search box, and then select **File Explorer**.
2. Select your hard drive designation. The hard drive designation is typically Local Disk (C:).
3. Using the hard drive path you recorded earlier, open the folder that contains the update.
4. Double-click the file that has an `.exe` extension (for example, `filename.exe`).  
The BIOS installation begins.
5. Complete the installation by following the on-screen instructions.



---

**NOTE:** After a message on the screen reports a successful installation, you can delete the downloaded file from your hard drive.

---

### Changing the boot order using the f9 prompt

To dynamically choose a boot device for the current startup sequence, follow these steps.

1. Access the Boot Device Options menu:
  - Turn on or restart the computer, and when the HP logo appears, press **f9** to enter the Boot Device Options menu.
2. Select a boot device, press **enter**, and then follow the on-screen instructions.

## TPM BIOS settings (select products only)

TPM provides additional security for your computer. You can modify the TPM settings in Computer Setup (BIOS).

---

 **IMPORTANT:** Before enabling Trusted Platform Module (TPM) functionality on this system, you must ensure that your intended use of TPM complies with relevant local laws, regulations and policies, and approvals or licenses must be obtained if applicable. For any compliance issues arising from your operation or usage of TPM that violates the previously mentioned requirement, you shall bear all the liabilities wholly and solely. HP will not be responsible for any related liabilities.

 **NOTE:** If you change the TPM setting to Hidden, TPM is not visible in the operating system.

---

To access TPM settings in Computer Setup:

1. Start Computer Setup. See [Using Computer Setup on page 72](#).
2. Select **Security**, select **TPM Embedded Security**, and then follow the on-screen instructions.

## Using HP Sure Start (select products only)

Select computer models are configured with HP Sure Start, a technology that monitors the computer's BIOS for attacks or corruption. If the BIOS becomes corrupted or is attacked, HP Sure Start automatically restores the BIOS to its previously safe state, without user intervention.

HP Sure Start is configured and already enabled so that most users can use the HP Sure Start default configuration. Advanced users can customize the default configuration.

To access the latest documentation on HP Sure Start, go to <http://www.hp.com/support>. Select **Find your product**, and then follow the on-screen instructions.

---

# 7 Backing up, restoring, and recovering

You can use Windows tools or HP software to back up your information, create a restore point, reset your computer, create recovery media, or restore your computer to its factory state. Performing these standard procedures can return your computer to a working state faster.

---

 **IMPORTANT:** If you are performing recovery procedures on a tablet, the tablet battery must be at least 70% charged before you start the recovery process.

 **IMPORTANT:** For a tablet with a detachable keyboard, connect the tablet to the keyboard base before beginning any recovery process.

---

# Backing up information and creating recovery media

These methods of creating recovery media and backups are available on select products only.

## Using Windows tools for backing up

HP recommends that you back up your information immediately after initial setup. You can do this task either using Windows Backup locally with an external USB flash drive or using online tools.

---

 **NOTE:** If computer storage is 32 GB or less, Microsoft® System Restore is disabled by default.

---

## Using the HP Cloud Recovery Download Tool to create recovery media (select products only)

You can use the HP Cloud Recovery Download Tool to create HP Recovery media on a bootable USB flash drive.

For details:

- Go to <http://www.hp.com>, search for HP Cloud Recovery, and then select the result that matches the type of computer that you have.

---

 **NOTE:** If you cannot create recovery media yourself, contact support to obtain recovery discs. Go to <http://www.hp.com/support>, select your country or region, and then follow the on-screen instructions.

 **IMPORTANT:** HP recommends that you follow the [Restoring and recovery methods on page 78](#) to restore your computer before you obtain and use the HP recovery discs. Using a recent backup can return your machine to a working state sooner than using the HP recovery discs. After the system is restored, reinstalling all the operating system software released since your initial purchase can be a lengthy process.

---

# Restoring and recovering your system

You have several tools available to recover your system both within and outside of Windows if the desktop cannot load.

HP recommends that you attempt to restore your system using the [Restoring and recovery methods on page 78](#).

## Creating a system restore

System Restore is available in Windows. The System Restore software can automatically or manually create restore points, or snapshots, of the system files and settings on the computer at a particular point.

When you use System Restore, it returns your computer to its state at the time you made the restore point. Your personal files and documents should not be affected.

## Restoring and recovery methods

After you run the first method, test to see whether the issue still exists before you proceed to the next method, which might now be unnecessary.

1. Run a Microsoft System Restore.
2. Run Reset this PC.



---

**NOTE:** The options **Remove everything** and then **Fully clean the drive** can take several hours to complete and leave no information on your computer. It is the safest way to reset your computer before you recycle it.

---

3. Recover using HP Recovery media. For more information, see [Recovering using HP Recovery media on page 78](#).

For more information about the first two methods, see the Get Help app:

- Select the **Start** button, select **All apps**, select the **Get Help** app, and then enter the task you want to perform.



---

**NOTE:** You must be connected to the internet to access the Get Help app.

---

## Recovering using HP Recovery media

You can use HP Recovery media to recover the operating system and drivers that were installed at the factory. On select products, you can create recovery media on a bootable USB flash drive using the HP Cloud Recovery Download Tool.

For details, see [Using the HP Cloud Recovery Download Tool to create recovery media \(select products only\) on page 77](#).



---

**NOTE:** If you cannot create recovery media yourself, contact support to obtain recovery discs. Go to <http://www.hp.com/support>, select your country or region, and then follow the on-screen instructions.

---

To recover your system:

- Insert the HP Recovery media, and then restart the computer.

 **NOTE:** HP recommends that you follow the [Restoring and recovery methods on page 78](#) to restore your computer before you obtain and use the HP recovery discs. Using a recent backup can return your machine to a working state sooner than using the HP recovery discs. After the system is restored, reinstalling all the operating system software released since your initial purchase can be a lengthy process.

---

## Changing the computer boot order

If your computer does not restart using the HP Recovery media, you can change the computer boot order, which is the order of devices listed in BIOS for startup information. You can select an optical drive or a USB flash drive, depending on the location of your HP Recovery media.

 **IMPORTANT:** For a tablet with a detachable keyboard, connect the tablet to the keyboard base before beginning these steps.

---

To change the boot order:

1. Insert the HP Recovery media.
2. Access the system **Startup** menu.
  - For computers or tablets with keyboards attached, turn on or restart the computer or tablet, quickly press **esc**, and then press **f9** for boot options.
  - For tablets without keyboards, turn on or restart the tablet, and then quickly press and hold one of the following buttons:
    - Volume up
    - Volume downThen select **f9**.
3. Select the optical drive or USB flash drive from which you want to boot, and then follow the on-screen instructions.

## Using HP Sure Recover (select products only)

Select computer models are configured with HP Sure Recover, a PC operating system (OS) recovery solution built into the hardware and software. HP Sure Recover can fully restore the HP OS image without installed recovery software.

Using HP Sure Recover, an administrator or user can restore the system and install:

- Latest version of the operating system
- Platform-specific device drivers
- Software applications, in the case of a custom image

To access the latest documentation for HP Sure Recover, go to <http://www.hp.com/support>. Follow the on-screen instructions to find your product and locate your documentation.

---

## 8 Using HP PC Hardware Diagnostics

You can use the HP PC Hardware Diagnostics utility to determine whether your computer hardware is running properly. The three versions are HP PC Hardware Diagnostics Windows, HP PC Hardware Diagnostics UEFI (Unified Extensible Firmware Interface), and (for select products only) Remote HP PC Hardware Diagnostics UEFI, a firmware feature.

## Using HP PC Hardware Diagnostics Windows (select products only)

HP PC Hardware Diagnostics Windows is a Windows-based utility that allows you to run diagnostic tests to determine whether the computer hardware is functioning properly. The tool runs within the Windows operating system to diagnose hardware failures.

If HP PC Hardware Diagnostics Windows is not installed on your computer, you must download and install it. To download HP PC Hardware Diagnostics Windows, see [Downloading HP PC Hardware Diagnostics Windows on page 82](#).

### Using an HP PC Hardware Diagnostics Windows hardware failure ID code

When HP PC Hardware Diagnostics Windows detects a failure that requires hardware replacement, a 24-digit failure ID code is generated for select component tests. For interactive tests, such as keyboard, mouse, or audio and video palette, you must perform troubleshooting steps before you can receive a failure ID.

You have several options after you receive a failure ID:

- Select **Next** to open the Event Automation Service (EAS) page, where you can log the case.
- Scan the QR code with your mobile device, which takes you to the EAS page, where you can log the case.
- Select the box next to the 24-digit failure ID to copy your failure code and send it to support.

### Accessing HP PC Hardware Diagnostics Windows

After HP PC Hardware Diagnostics Windows is installed, you can access it from HP Support Assistant or the Start menu.

#### Accessing HP PC Hardware Diagnostics Windows from HP Support Assistant

After HP PC Hardware Diagnostics Windows is installed, follow these steps to access it from HP Support Assistant:

1. Complete one of the following tasks:
  - Select the **Search** icon in the taskbar, type `support` in the search box, and then select the **HP Support Assistant** app.
  - Select the question mark icon in the taskbar.
2. Select **Fixes & Diagnostics**.
3. Select **Run hardware diagnostics**, and then select **Launch**.
4. When the tool opens, select the type of diagnostic test that you want to run, and then follow the on-screen instructions.



---

**NOTE:** To stop a diagnostic test, select **Cancel**.

---

#### Accessing HP PC Hardware Diagnostics Windows from the Start menu (select products only)

After HP PC Hardware Diagnostics Windows is installed, follow these steps to access it from the Start menu:

1. Select the **Start** button, and then select **All apps**.
2. Select **HP PC Hardware Diagnostics Windows**.
3. When the tool opens, select the type of diagnostic test that you want to run, and then follow the on-screen instructions.



---

**NOTE:** To stop a diagnostic test, select **Cancel**.

---

## Downloading HP PC Hardware Diagnostics Windows

The HP PC Hardware Diagnostics Windows downloading instructions are provided in English only. You must use a Windows computer to download this tool because only .exe files are provided.

### Downloading the latest HP PC Hardware Diagnostics Windows version from HP

To download HP PC Hardware Diagnostics Windows from HP, follow these steps:

1. Go to <http://www.hp.com/go/techcenter/pcdiags>. The HP PC Diagnostics home page is displayed.
2. Select **Download HP Diagnostics Windows**, and then select the specific Windows diagnostics version to download to your computer or a USB flash drive.

The tool downloads to the selected location.

### Downloading the HP PC Hardware Diagnostics Windows from the Microsoft Store

You can download the HP PC Hardware Diagnostics Windows from the Microsoft Store:

1. Select the Microsoft Store app on your desktop or select the **Search** icon in the taskbar, and then type `Microsoft Store` in the search box.
2. Type `HP PC Hardware Diagnostics Windows` in the **Microsoft Store** search box.
3. Follow the on-screen directions.

The tool downloads to the selected location.

### Downloading HP Hardware Diagnostics Windows by product name or number (select products only)

You can download HP PC Hardware Diagnostics Windows by product name or number.



---

**NOTE:** For some products, you might have to download the software to a USB flash drive by using the product name or number.

---

1. Go to <http://www.hp.com/support>.
2. Select **Software and Drivers**, select your type of product, and then enter the product name or number in the search box that is displayed.
3. In the **Diagnostics** section, select **Download**, and then follow the on-screen instructions to select the specific Windows diagnostics version to be downloaded to your computer or USB flash drive.

The tool downloads to the selected location.

## Installing HP PC Hardware Diagnostics Windows

To install HP PC Hardware Diagnostics Windows, navigate to the folder on your computer or the USB flash drive where the .exe file downloaded, double-click the .exe file, and then follow the on-screen instructions.

## Using HP PC Hardware Diagnostics UEFI

HP PC Hardware Diagnostics Unified Extensible Firmware Interface (UEFI) allows you to run diagnostic tests to determine whether the computer hardware is functioning properly. The tool runs outside the operating system so that it can isolate hardware failures from issues that are caused by the operating system or other software components.

---

 **NOTE:** For some products, you must use a Windows computer and a USB flash drive to download and create the HP UEFI support environment because only .exe files are provided. For more information, see [Downloading HP PC Hardware Diagnostics UEFI to a USB flash drive on page 85](#).

---

If your PC does not start in Windows, you can use HP PC Hardware Diagnostics UEFI to diagnose hardware issues.

### Using an HP PC Hardware Diagnostics UEFI hardware failure ID code

When HP PC Hardware Diagnostics UEFI detects a failure that requires hardware replacement, a 24-digit failure ID code is generated.

For assistance in solving the problem, complete one of these tasks:

- Select **Contact HP**, accept the HP privacy disclaimer, and then use a mobile device to scan the failure ID code that appears on the next screen. The HP Customer Support - Service Center page appears with your failure ID and product number automatically filled in. Follow the on-screen instructions.
- Contact support, and provide the failure ID code.

### Starting HP PC Hardware Diagnostics UEFI

To start HP PC Hardware Diagnostics UEFI, follow this procedure.

1. Turn on or restart the computer, and quickly press **esc**.
2. Press **f2**.

The BIOS searches three places for the diagnostic tools, in the following order:

- a. Connected USB flash drive

---

 **NOTE:** To download the HP PC Hardware Diagnostics UEFI tool to a USB flash drive, see [Downloading the latest HP PC Hardware Diagnostics UEFI version on page 85](#).

---

- b. Hard drive
  - c. BIOS
3. When the diagnostic tool opens, select the type of diagnostic test that you want to run, and then follow the on-screen instructions.

## Starting HP PC Hardware Diagnostics UEFI through HP Hotkey Support software (select products only)

This section describes how to start HP PC Hardware Diagnostics UEFI through HP Hotkey Support software.

---

 **NOTE:** You must disable fast boot to access HP PC Hardware Diagnostics UEFI from the HP System Information application.

To disable fast boot:

1. Turn on or restart the computer, and when the HP logo appears, press **f10** to enter Computer Setup.
  2. Select **Advanced**, and then select **Boot Options**.
  3. Clear **Fast Boot**.
  4. Select **Save Changes and Exit**, and then select **Yes**.
- 

To start HP PC Hardware Diagnostics UEFI through HP Hotkey Support software, follow this procedure.:

1. From the **Start** menu, open the HP System Information Application or press **fn+esc**.
2. In HP System Information screen, select **Run System Diagnostics**, select **Yes** to run the application, and then select **Restart**.

---

 **IMPORTANT:** To prevent loss of data, save your work in all open apps before restarting your computer.

 **NOTE:** When the restart is complete, the computer opens the HP PC Hardware Diagnostics UEFI Application. Proceed with the troubleshooting tests.

---

## Downloading HP PC Hardware Diagnostics UEFI to a USB flash drive

Downloading HP PC Hardware Diagnostics UEFI to a USB flash drive can be useful in some situations.

- HP PC Hardware Diagnostics UEFI is not included in the preinstallation image.
- HP PC Hardware Diagnostics UEFI is not included in the HP Tool partition.
- The hard drive is damaged.

---

 **NOTE:** The HP PC Hardware Diagnostics UEFI downloading instructions are provided in English only, and you must use a Windows computer to download and create the HP UEFI support environment because only `.exe` files are provided.

---

## Downloading the latest HP PC Hardware Diagnostics UEFI version

To download the latest HP PC Hardware Diagnostics UEFI version to a USB flash drive, follow this procedure:

1. Go to <http://www.hp.com/go/techcenter/pcdiags>. The HP PC Diagnostics home page is displayed.
2. Select **Download HP Diagnostics UEFI**, and then select **Run**.

## Downloading HP PC Hardware Diagnostics UEFI by product name or number (select products only)

You can download HP PC Hardware Diagnostics UEFI by product name or number (select products only) to a USB flash drive.



**NOTE:** For some products, you might have to download the software to a USB flash drive by using the product name or number.

---

1. Go to <http://www.hp.com/support>.
2. Enter the product name or number, select your computer, and then select your operating system.
3. In the **Diagnostics** section, follow the on-screen instructions to select and download the specific UEFI Diagnostics version for your computer.

## Using Remote HP PC Hardware Diagnostics UEFI settings (select products only)

Remote HP PC Hardware Diagnostics UEFI is a firmware (BIOS) feature that downloads HP PC Hardware Diagnostics UEFI to your computer. It can then run the diagnostics on your computer, and it might upload results to a preconfigured server.

For more information about Remote HP PC Hardware Diagnostics UEFI, go to <http://www.hp.com/go/techcenter/pcdiags>, and then select **Find out more**.

### Downloading Remote HP PC Hardware Diagnostics UEFI

Remote HP PC Hardware Diagnostics UEFI is also available as a SoftPaq that you can download to a server.

### Downloading the latest Remote HP PC Hardware Diagnostics UEFI version

You can download the latest Remote HP PC Hardware Diagnostics UEFI version to a USB flash drive.

1. Go to <http://www.hp.com/go/techcenter/pcdiags>. The HP PC Diagnostics home page is displayed.
2. Select **Download Remote Diagnostics**, and then select **Run**.

### Downloading Remote HP PC Hardware Diagnostics UEFI by product name or number

You can download Remote HP PC Hardware Diagnostics UEFI by product name or number.

---

 **NOTE:** For some products, you might have to download the software by using the product name or number.

---

1. Go to <http://www.hp.com/support>.
2. Select **Software and Drivers**, select your type of product, enter the product name or number in the search box that is displayed, select your computer, and then select your operating system.
3. In the **Diagnostics** section, follow the on-screen instructions to select and download the **Remote UEFI** version for the product.

### Customizing Remote HP PC Hardware Diagnostics UEFI settings

Using the Remote HP PC Hardware Diagnostics setting in Computer Setup (BIOS), you can perform several customizations.

- Set a schedule for running diagnostics unattended. You can also start diagnostics immediately in interactive mode by selecting **Execute Remote HP PC Hardware Diagnostics UEFI**.
- Set the location for downloading the diagnostic tools. This feature provides access to the tools from the HP website or from a server that has been preconfigured for use. Your computer does not require the traditional local storage, such as a hard drive or USB flash drive, to run remote diagnostics.
- Set a location for storing the test results. You can also set the user name and password that you use for uploads.
- Display status information about the diagnostics run previously.

To customize Remote HP PC Hardware Diagnostics UEFI settings, follow these steps:

1. Turn on or restart the computer, and when the HP logo appears, press **f10** to enter Computer Setup.
2. Select **Advanced**, and then select **Settings**.
3. Make your customization selections.
4. Select **Main**, then select **Save Changes and Exit** to save your settings.

Your changes take effect when the computer restarts.

# 9 Specifications

This chapter provides specifications for your computer system.

## Computer specifications

This section provides specifications for your computer. When you travel with your computer, the computer dimensions and weights, as well as input power ratings and operating specifications, provide helpful information.

**Table 9-1** Computer specifications

	Metric	U.S.
<b>Dimensions</b>		
Width	385.0 mm	15.2 in
Depth	258.0 mm	10.2 in
Height (front to back)	23.0 mm	0.9 in
<b>Weight</b>		
	2.1 kg	4.6 lb
<b>Input power</b>		
Operating voltage and current	19.5 V DC @ 2.31 A - 45 W	
	19.5 V DC @ 3.33 A - 65 W	
	19.5 V DC @ 4.62 A - 90 W	
	19.5 V DC @ 7.70 A - 150 W	
	19.5 V DC @ 10.3 A - 200 W	
<b>Temperature</b>		
Operating	5°C to 35°C	41°F to 95°F
Nonoperating	-20°C to 60°C	-4°F to 140°F
<b>Relative humidity</b> (noncondensing)		
Operating	10% to 90%	
Nonoperating	5% to 95%	
<b>Maximum altitude</b> (unpressurized)		
Operating	-15 m to 3,048 m	-50 ft to 10,000 ft

**Table 9-1 Computer specifications (continued)**

	Metric	U.S.
Nonoperating	-15 m to 12,192 m	-50 ft to 40,000 ft



**NOTE:** Applicable product safety standards specify thermal limits for plastic surfaces. The device operates well within this range of temperatures.

## Display specifications

This section provides specifications for your display.

**Table 9-2 Display specifications**

	Metric	U.S.
Active diagonal size	<b>35.6 cm</b>	14.0 in
Resolution	2880 × 1800 (2.8K) 1920 × 1080 (WUXGA)	
Surface treatment	Antiglare (WLED and LED panels) Brightview (OLED panel)	
Brightness	1000 nits (WUXGA, sRGB 100 panel) 800 nits (WUXGA, LBL panel) 400 nits (OLED + LBL and LED panel)	
Viewing angle	UWVA	
Backlight	OLED WLED LED	
Display panel interface	eDP	

## Solid-state drive specifications

This section provides specifications for your solid-state drives.

**Table 9-3 Solid-state drive specifications**

	256 GB*	512 GB*	1TB*
<b>Dimensions</b>			
Height	1.0 mm	1.0 mm	1.0 mm
Length	50.8 mm	50.8 mm	50.8 mm
Width	28.9 mm	28.9 mm	28.9 mm

**Table 9-3 Solid-state drive specifications (continued)**

	<b>256 GB*</b>	<b>512 GB*</b>	<b>1 TB*</b>
Weight	< 10 g	< 10 g	< 10 g
<b>Interface type</b>	PCIe	PCIe	PCIe
Ready time, maximum (to not busy)	1.0 ms	< 1.0 ms	1.0 ms
Access times, logical	0.1 ms	0.1 ms	0.1 ms
<b>Transfer rate</b>			
Sequential read	up to 2150 MBps	up to 2150 MBps	up to 2150 MBps
Random read	Up to 300,000 IOPs	Up to 300,000 IOPs	Up to 300,000 IOPs
Sequential write	up to 1550 MBps	up to 1550 MBps	up to 1550 MBps
Random write	Up to 100,000 IOPs	Up to 100,000 IOPs	Up to 100,000 IOPs
<b>Total logical sectors</b>	468,883,296	1,000,215,216	1,500,336,388
<b>Operating temperature</b>	<b>0°C to 70°C</b> (32°F to 158°F)	<b>0°C to 70°C</b> (32°F to 158°F)	<b>0°C to 70°C</b> (32°F to 158°F)

 **NOTE:** \*1 GB = 1 billion bytes when referring to hard drive storage capacity. Actual accessible capacity is less. Actual drive specifications might differ slightly.

Certain restrictions and exclusions apply. Contact support for details.

---

# 10 Statement of memory volatility

For general information regarding nonvolatile memory in HP business computers, and to restore nonvolatile memory that can contain personal data after the system has been turned off and the hard drive has been removed, use these instructions.

HP business computer products that use Intel®-based or AMD®-based system boards contain volatile DDR memory. The amount of nonvolatile memory present in the system depends upon the system configuration. Intel-based and AMD-based system boards contain nonvolatile memory subcomponents as originally shipped from HP, with the following assumptions:

- No subsequent modifications were made to the system.
- No applications, features, or functionality were added to or installed on the system.

Following system shutdown and removal of all power sources from an HP business computer system, personal data can remain on volatile system memory (DIMMs) for a finite period of time and also remains in nonvolatile memory. Use the following steps to remove personal data from the computer, including the nonvolatile memory found in Intel-based and AMD-based system boards.



**NOTE:** If your tablet has a keyboard base, connect to the keyboard base before beginning steps in this chapter.

---

## Current BIOS steps

Use these instructions to restore nonvolatile memory.

1. Follow these steps to restore the nonvolatile memory that can contain personal data. Restoring or reprogramming nonvolatile memory that does not store personal data is neither necessary nor recommended.
  - a. Turn on or restart the computer, and then quickly press **esc**.



**NOTE:** If the system has a BIOS administrator password, type the password at the prompt.

---

- b. Select **Main**, select **Apply Factory Defaults and Exit**, and then select **Yes** to load defaults. The computer restarts.
- c. During the restart, press **esc** while the "Press the ESC key for Startup Menu" message is displayed at the bottom of the screen.



**NOTE:** If the system has a BIOS administrator password, type the password at the prompt.

---

- d. Select the **Security** menu, select **Restore Security Settings to Factory Defaults**, and then select **Yes** to restore security level defaults. The computer restarts.
- e. During the restart, press **esc** while the "Press the ESC key for Startup Menu" message is displayed at the bottom of the screen.



---

**NOTE:** If the system has a BIOS administrator password, type the password at the prompt.

---

- f. If an asset or ownership tag is set, select the **Security** menu and scroll down to the **Utilities** menu. Select **System IDs**, and then select **Asset Tracking Number**. Clear the tag, and then make the selection to return to the prior menu.
- g. If a DriveLock password is set, select the **Security** menu, and scroll down to **Hard Drive Utilities** under the **Utilities** menu. Select **Hard Drive Utilities**, select **DriveLock**, and then clear the check box for **DriveLock password on restart**. Select **OK** to proceed.
- h. Select the **Main** menu, and then select **Reset BIOS Security to factory default**. Select **Yes** at the warning message. The computer restarts.
- i. During the restart, press **esc** while the "Press the ESC key for Startup Menu" message is displayed at the bottom of the screen.



---

**NOTE:** If the system has a BIOS administrator password, type the password at the prompt.

---

- j. Select the **Main** menu, select **Apply Factory Defaults and Exit**, select **Yes** to save changes and exit, and then select **Shutdown**.
  - k. Restart the system. If the system has a Trusted Platform Module (TPM), fingerprint reader, or both, one or two prompts will appear—one to clear the TPM and the other to Reset Fingerprint Sensor. Press or tap **f1** to accept or **f2** to reject.
  - l. Remove all power and system batteries for at least 24 hours.
2. Complete one of the following:
- Remove and retain the storage drive.  
- or -
  - Clear the drive contents by using a third-party utility designed to erase data from an SSD.  
- or -
  - Clear the contents of the drive by using the following BIOS Setup Secure Erase command option steps:



---

**NOTE:** If you clear data using Secure Erase, you cannot recover it.

---

- a. Turn on or restart the computer, and then quickly press **esc**.
- b. Select the **Security** menu and scroll down to the **esc** menu.
- c. Select **Hard Drive Utilities**.
- d. Under **Utilities**, select **Secure Erase**, select the hard drive storing the data you want to clear, and then follow the on-screen instructions to continue.  
  
- or -

Clear the contents of the drive using the following Disk Sanitizer commands steps:

- i. Turn on or restart the computer, and then quickly press **esc**.
- ii. Select the **Security** menu and scroll down to the **Utilities** menu.
- iii. Select **Hard Drive Utilities**.
- iv. Under **Utilities**, select **Disk Sanitizer**, select the hard drive with the data that you want to clear, and then follow the on-screen instructions to continue.



**NOTE:** The amount of time it takes for Disk Sanitizer to run can take several hours. Plug the computer into an AC outlet before starting.

## Nonvolatile memory usage

Use this table to troubleshoot nonvolatile memory usage.

**Table 10-1 Troubleshooting steps for nonvolatile memory usage**

Description	Volatility description	Storage user data	How to erase
Primary storage device, holds the OS, applications, and application settings	Non-volatile, 8-256 GB of eMMC or NVMe SSD storage, removable	Yes <sup>1</sup>	Follow instructions below under “Erase the Primary Storage Device”
System memory (RAM), holds transient data during system operation	Volatile, SODIMM socket. Removable (4 GB/8 GB/16 GB)	Yes	Unplug unit from power
Permanent system BIOS settings	Non-volatile; 16 KB; stored	No <sup>2</sup>	Follow instructions below under “Clearing BIOS Settings”
System boot ROM (BIOS)	Non-volatile memory, 128 Mbit (16 MB) socketed, removable	No	Download the latest BIOS for your model from the HP website and follow the instructions to flash the BIOS that are on the website
RTC (CMOS) RAM	Volatile memory, 256 bytes located in AMD embedded System on Chip (SoC)	No	Unplug unit from main power, remove top cover and press <b>Clear CMOS</b> button
Keyboard/mouse (ROM)	Non-volatile, 2 KB embedded in the super I/O controller (SIO2)	Yes	N/A
Keyboard/mouse (RAM)	Volatile, 256 bytes embedded in the super I/O controller (SIO2)	No	Unplug unit from main power
LOM EEPROM	Non-volatile, 2 MB embedded in LAN controller	No	N/A
Trusted Platform Module (TPM)	Non-volatile; 51 KB ROM for firmware and 38 KB system parametric data	No <sup>3</sup>	Follow instructions below under “Clearing TPM”

<sup>1</sup> Under typical operation, the only user data stored on the primary storage device are preferences for device configuration and settings for connections. However, the administrator can configure the system to allow users to store data locally.

<sup>2</sup> The only user data potentially stored in BIOS Settings are the ownership and asset tags, administrator password, and startup password.

<sup>3</sup> The Trusted Platform Module may contain encrypted passwords or certificates generated from user or administrator input.

## Questions and answers

Use this section to answer your questions about nonvolatile memory.

### 1. How can the BIOS settings be restored (returned to factory settings)?

 **IMPORTANT:** The restore defaults feature does not securely erase any information on your hard drive. See question and answer 6 for steps to securely erase information.

The restore defaults feature does not reset the Custom Secure Boot keys. See question and answer 7 for information about resetting the keys.

- a. Turn on or restart the computer, and then quickly press **esc**.
- b. Select **Main**, and then select **Apply Factory Defaults and Exit**.
- c. Follow the on-screen instructions.
- d. Select **Main**, select **Save Changes and Exit**, and then follow the on-screen instructions.

### 2. What is a UEFI BIOS, and how is it different from a legacy BIOS?

The Unified Extensible Firmware Interface (UEFI) BIOS is an industry-standard software interface between the platform firmware and an operating system (OS). It replaces the older BIOS architecture but supports much of the legacy BIOS functionality.

Like the legacy BIOS, the UEFI BIOS provides an interface to display the system information and configuration settings and to change the configuration of your computer before an OS is loaded. BIOS provides a secure runtime environment that supports a Graphic User Interface (GUI). In this environment, you can use either a pointing device (touch screen, touchpad, pointing stick, or USB mouse) or the keyboard to navigate and make menu and configuration selections. The UEFI BIOS also contains basic system diagnostics.

The UEFI BIOS provides functionality beyond that of the legacy BIOS. In addition, the UEFI BIOS works to initialize the computer's hardware before loading and executing the OS; the runtime environment allows the loading and execution of software programs from storage devices to provide more functionality, such as advanced hardware diagnostics (with the ability to display more detailed system information) and advanced firmware management and recovery software.

HP has provided options in Computer Setup (BIOS) to allow you to run in legacy BIOS, if required by the operating system. Examples of this requirement would be if you upgrade or downgrade the OS.

### 3. Where is the UEFI BIOS located?

The UEFI BIOS is located on a flash memory chip. You must use a utility to write to the chip.

### 4. What kind of configuration data is stored on the DIMM Serial Presence Detect (SPD) memory module? How would this data be written?

The DIMM SPD memory contains information about the memory module, such as size, serial number, data width, speed and timing, voltage, and thermal information. This information is written by the module manufacturer and stored on an EEPROM. You cannot write to this EEPROM when the memory module is installed in a computer. Third-party tools do exist that can write to the EEPROM when the memory module is not installed in a computer. Various third-party tools are available to read SPD memory.

**5. What is meant by “Restore the nonvolatile memory found in Intel-based system boards”?**

This message relates to clearing the Real Time Clock (RTC) CMOS memory that contains computer configuration data.

**6. How can the BIOS security be reset to factory defaults and erase the data?**

---

 **IMPORTANT:** Resetting results in the loss of information.

These steps do not reset Custom Secure Boot Keys. See question and answer 7 for information about resetting the keys.

---

- a. Turn on or restart the computer, and then quickly press **esc**.
- b. Select **Main**, and then select **Reset Security to Factory Defaults**.
- c. Follow the on-screen instructions.
- d. Select **Main**, select **Save Changes and Exit**, and then follow the on-screen instructions.

**7. How can the Custom Secure Boot Keys be reset?**

Secure Boot is a feature to ensure that only authenticated code can start on a platform. If you enabled Secure Boot and created Custom Secure Boot Keys, disabling Secure Boot does not clear the keys. You must also select to clear the Custom Secure Boot Keys. Use the same Secure Boot access procedure that you used to create the Custom Secure Boot Keys, but select to clear or delete all Secure Boot Keys.

- a. Turn on or restart the computer, and then quickly press **esc**.
- b. Select the **Security** menu, select **Secure Boot Configuration**, and then follow the on-screen instructions.
- c. At the **Secure Boot Configuration** window, select **Secure Boot**, select **Clear Secure Boot Keys**, and then follow the on-screen instructions to continue.

## Using HP Sure Start (select products only)

Select computer models are configured with HP Sure Start, a technology that continuously monitors your computer's BIOS for attacks or corruption.

If the BIOS becomes corrupted or is attacked, HP Sure Start restores the BIOS to its previously safe state, without user intervention. Those select computer models ship with HP Sure Start configured and enabled. HP Sure Start is configured and already enabled so that most users can use the HP Sure Start default configuration. Advanced users can customize the default configuration.

To access the latest documentation on HP Sure Start, go to <http://www.hp.com/support>.

# 11 Power cord set requirements

This chapter provides power cord requirements for countries and regions.

The wide-range input feature of the computer permits it to operate from any line voltage from 100 V AC to 120 V AC, or from 220 V AC to 240 V AC.

The three-conductor power cord set included with the computer meets the requirements for use in the country or region where the equipment is purchased.

Power cord sets for use in other countries or regions must meet the requirements of the country and region where the computer is used.

## Requirements for all countries

These power cord requirements are applicable to all countries and regions.

- The length of the power cord set must be at least **1.0 m** (3.3 ft) and no more than **2.0 m** (6.5 ft).
- All power cord sets must be approved by an acceptable accredited agency responsible for evaluation in the country or region where the power cord set will be used.
- The power cord sets must have a minimum current capacity of 10 A and a nominal voltage rating of 125 V AC or 250 V AC, as required by the power system of each country or region.
- The appliance coupler must meet the mechanical configuration of an EN 60 320/IEC 320 Standard Sheet C13 connector for mating with the appliance inlet on the back of the computer.

## Requirements for specific countries and regions

To determine power cord requirements for specific countries and regions, use this table.

**Table 11-1** Power cord requirements for specific countries and regions

Country/region	Accredited agency	Applicable note number
Argentina	IRAM	1
Australia	SAA	1
Austria	OVE	1
Belgium	CEBEC	1
Brazil	ABNT	1
Canada	CSA	2

**Table 11-1 Power cord requirements for specific countries and regions (continued)**

Country/region	Accredited agency	Applicable note number
Chile	IMQ	1
Denmark	DEMKO	1
Finland	FIMKO	1
France	UTE	1
Germany	VDE	1
India	BIS	1
Israel	SII	1
Italy	IMQ	1
Japan	JIS	3
Netherlands	KEMA	1
New Zealand	SANZ	1
Norway	NEMKO	1
People's Republic of China	CCC	4
Saudi Arabia	SASO	7
Singapore	PSB	1
South Africa	SABS	1
South Korea	KTL	5
Sweden	SEMKO	1
Switzerland	SEV	1
Taiwan	BSMI	6
Thailand	TISI	1
United Kingdom	ASTA	1
United States	UL	2

1. The flexible cord must be Type HO5VV-F, three-conductor, 0.75 mm<sup>2</sup> conductor size. Power cord set fittings (appliance coupler and wall plug) must bear the certification mark of the agency responsible for evaluation in the country or region where it will be used.
2. The flexible cord must be Type SVT/SJT or equivalent, No. 18 AWG, three-conductor. The wall plug must be a two-pole grounding type with a NEMA 5-15P (15 A, 125 V AC) or NEMA 6-15P (15 A, 250 V AC) configuration. CSA or C-UL mark. UL file number must be on each element.
3. The appliance coupler, flexible cord, and wall plug must bear a T mark and registration number in accordance with the Japanese Dentori Law. The flexible cord must be Type VCTF, three-conductor, 0.75 mm<sup>2</sup> or 1.25 mm<sup>2</sup> conductor size. The wall plug must be a two-pole grounding type with a Japanese Industrial Standard C8303 (7 A, 125 V AC) configuration.
4. The flexible cord must be Type RVV, three-conductor, 0.75 mm<sup>2</sup> conductor size. Power cord set fittings (appliance coupler and wall plug) must bear the CCC certification mark.

5. The flexible cord must be Type H05VV-F three-conductor, 0.75 mm<sup>2</sup> conductor size. KTL logo and individual approval number must be on each element. Approval number and logo must be printed on a flag label.
6. The flexible cord must be Type HVCTF three-conductor, 1.25 mm<sup>2</sup> conductor size. Power cord set fittings (appliance coupler, cable, and wall plug) must bear the BSMI certification mark.
7. For 127 V AC, the flexible cord must be Type SVT or SJT 3-conductor, 18 AWG, with plug NEMA 5-15P (15 A, 125 V AC), with UL and CSA or C-UL marks. For 240 V AC, the flexible cord must be Type H05VV-F three-conductor, 0.75 mm<sup>2</sup> or 1.00 mm<sup>2</sup> conductor size, with plug BS 1363/A with BSI or ASTA marks.

---

## 12 Recycling

When a nonrechargeable or rechargeable battery has reached the end of its useful life, do not dispose of the battery in general household waste. Follow the local laws and regulations in your area for battery disposal.

HP encourages customers to recycle used electronic hardware, HP original print cartridges, and rechargeable batteries. For more information about recycling programs, see the HP website at <http://www.hp.com/recycle>.

# Index

## Symbols/Numerics

360 modes, identifying 8

## A

AC adapter

    spare part numbers 28

action keys, identifying 16

adapter

    spare part numbers 28

ambient light and color sensor,  
    identifying 10

audio-out (headphone)/audio-in  
(microphone) combo jack,  
    identifying 8

audio, product description 2

Auto Lock and Awake 9

## B

backpack

    spare part numbers 28

backup, creating 76

backups 76, 77

bag

    spare part numbers 28

battery

    illustrated 27

    removal 45

    spare part numbers 27, 45

battery light 6, 7

BIOS

    determining version 73

    downloading an update 73, 74

    updating 73

Bluetooth label 18

boot order

    changing using the f9  
    prompt 74

boot order, changing 79

bottom cover

    illustrated 27

    removal 44

    spare part numbers 27, 44

Bracket Kit

    contents 28

    spare part number 28

buttons

    left touchpad 12

    power 15, 16

    right touchpad 12

## C

cable

    spare part numbers 28

Cable Kit

    contents 29

    spare part number 29

camera 10

    identifying 10

camera light, identifying 9

camera privacy cover,  
    identifying 10

caps lock light, identifying 13

caring for your computer 38

cautions

    electrostatic discharge 33, 35

cleaning your computer 38

    caring for wood veneer 40

    disinfecting 39

    HP Easy Clean 38

    removing dirt and debris 38

components

    bottom 16

    display 9

    keyboard area 11

    left side 6

    rear 17

    right side 5

Computer Setup

    navigating and selecting 72

    restoring factory settings 72

    starting 72

computer specifications 89

connector, power 6, 7

## D

display

    specifications 89, 90

display assembly

    illustrated 23

    removal 59

    spare part numbers 23, 59

display components 9

display panel

    product description 1

dock

    spare part numbers 29

duck head adapter, spare part  
    number 29

## E

electrostatic discharge (ESD) 33,  
    35

    preventing damage 33, 35, 36

eMMC

    product description 2

esc key, identifying 15

## F

fan/heat sink assembly

    removal 56

    spare part numbers 56

fingerprint reader

    illustrated 24

    removal 58

    spare part number 24, 58

fingerprint reader board cable

    spare part number 24

fingerprint reader cable

    illustrated 24

    removal 57

    spare part number 57

fingerprint reader, identifying 14

fn key, identifying 15

fn lock light, identifying 13

- G**
- graphics, product description 1
  - grounding methods 33, 35, 36
  - guidelines
    - packaging 33, 40
    - transporting 33, 40
    - workstation 33, 34
- H**
- hard drive
    - product description 2
    - specifications 89
  - hardware, locating 5
  - HDMI port, identifying 7
  - headset, spare part number 29
  - heat sink
    - illustrated 27
    - spare part number 27
  - HP PC Hardware Diagnostics UEFI
    - downloading 85
    - failure ID code 84
    - HP Hotkey Support software 85
    - starting 84, 85
    - using 84
  - HP PC Hardware Diagnostics Windows
    - accessing 81
    - downloading 82
    - failure ID code 81
    - installing 83
    - using 81
  - HP Recovery media recovery 78
  - HP Sure Recover 79
  - HP Sure Start 92, 96
  - hub, spare part numbers 29
- I**
- I/O bracket
    - illustrated 27
    - spare part number 27
  - I/O bracket holder
    - illustrated 27
    - spare part number 27
  - illustrated parts catalog 22
  - internal microphones, identifying 9
- J**
- jacks
    - audio-out (headphone)/audio-in (microphone) combo 8
- K**
- keyboard
    - product description 3
  - keyboard, spare part number 29
  - keys
    - action 16
    - esc 15
    - fn 15
    - Windows 16
    - Windows Copilot 16
- L**
- labels
    - Bluetooth 18
    - regulatory 18
    - serial number 18
    - service 18
    - wireless certification 18
    - WLAN 18
  - left side components 6
  - lights
    - AC adapter and battery 6, 7
    - battery 6, 7
    - camera 9
    - caps lock 13
    - fn lock 13
    - microphone mute 13
    - power 13
    - privacy key 13
  - lights, mute 13
  - lock
    - spare part number 29
  - low blue light mode 9
- M**
- magnetic pen attachment area, identifying 8
  - memory
    - nonvolatile 92
    - volatile 92
  - memory module
    - product description 2
  - microphone
    - product description 2
  - microphone mute light, identifying 13
  - middle hook holder
    - illustrated 27
    - spare part number 27
  - model name 1
  - mouse, spare part numbers 29
  - mute light, identifying 13
- N**
- nano SIM card slot, identifying 5
  - nano SIM card, inserting 20
  - Near Field Communications (NFC) tapping area and antenna, identifying 12
  - NFC module
    - illustrated 24
    - removal 64
    - spare part number 24, 64
  - NFC module cable
    - removal 63
    - spare part number 63
  - NFC module, product description 3
  - nonvolatile memory 92
- O**
- operating system, product description 4
  - optical drive, spare part number 29
- P**
- packaging guidelines 33, 40
  - pointing device, product description 3
  - ports
    - HDMI 7
    - product description 3
    - USB port with HP Sleep and Charge 6
    - USB Type-C power connector and port with HP Sleep and Charge 6
    - USB Type-C power connector and Thunderbolt port with HP Sleep and Charge 7
  - power button
    - illustrated 24
    - spare part number 24
  - power button, identifying 15, 16
  - power connector
    - identifying USB Type-C 6, 7
  - power cord
    - requirements for all countries 97
    - requirements for specific countries and regions 97
    - set requirements 97
    - spare part numbers 29-32
  - power lights 13

- power requirements, product description 3
- primary storage
  - product description 2
- privacy key light 13
- processor
  - product description 1
- product description
  - audio 2
  - display panel 1
  - eMMC 2
  - graphics 1
  - hard drive 2
  - keyboard 3
  - memory module 2
  - microphone 2
  - NFC module 3
  - operating system 4
  - pointing device 3
  - ports 3
  - power requirements 3
  - primary storage 2
  - processors 1
  - product name 1
  - security 3
  - sensors 3
  - serviceability 4
  - solid-state drive 2
  - video 2
  - wireless 2
- product name 1
- product name and number, computer 18

## R

- recovery 76, 78
  - discs 78
  - media 78
  - USB flash drive 78
- recovery media 77
  - creating using HP Cloud Recovery Download Tool 77
  - creating using Windows tools 77
- regulatory information
  - regulatory label 18
  - wireless certification labels 18
- Remote HP PC Hardware Diagnostics UEFI settings
  - customizing 87
  - using 87
- removal and replacement procedures 44

- removing personal data from volatile system memory 92
- restoring 76
- restoring and recovery methods 78
- right side components 5

## S

- Screw Kit, spare part number 32
- security cable slot, identifying 6
- security, product description 3
- sensors, product description 3
- serial number, computer 18
- service labels, locating 18
- serviceability, product description 4
- setup utility
  - navigating and selecting 72
  - restoring factory settings 72
- SIM card, correct size 20
- SIM card, inserting 20
- slots
  - nano SIM card 5
  - security cable 6
- software installed, locating 5
- solid-state drive
  - product description 2
  - specifications 90
- spare part country codes 69
- speakers
  - illustrated 27
  - removal 62
  - spare part number 27, 62
- speakers, identifying 14, 17
- special keys, using 15
- specifications
  - computer 89
  - display 89, 90
  - hard drive 89
  - solid-state drive 90
- SSD
  - illustrated 24
  - removal 48
  - spare part numbers 24, 48
- SSD bracket
  - illustrated 25, 49
  - spare part number 25, 49
- static electricity 33, 35
- support information 40
- Sure Start
  - using 75
- system board
  - illustrated 25
  - removal 51

- spare part numbers 25, 51
- system memory, removing
  - personal data from volatile 92
- system restore 78
- system restore point, creating 77

## T

- top cover with keyboard
  - illustrated 24
  - spare part numbers 24, 69
- touchpad
  - illustrated 24
  - removal 66
  - settings 11
  - spare part numbers 24, 66
- touchpad buttons
  - identifying 12
- touchpad cable
  - illustrated 24
  - removal 65
  - spare part number 24, 65
- touchpad zone, identifying 12
- TPM settings 75
- transfer board
  - illustrated 24
  - removal 68
  - spare part number 24, 68
- transfer board cable
  - illustrated 24
  - removal 67
  - spare part number 24, 67
- transporting guidelines 33, 40
- traveling with the computer 18

## U

- USB port with HP Sleep and Charge, identifying 6
- USB Type-C power connector and port with HP Sleep and Charge, identifying 6
- USB Type-C power connector and Thunderbolt port with HP Sleep and Charge, identifying 7
- user-proximity sensor, identifying 10

## V

- vents, identifying 17
- video, product description 2

## W

- Windows
  - backup 76

- recovery media 76
- system restore point 77
- Windows Copilot key,
  - identifying 16
- Windows key, identifying 16
- Windows tools, using 77
- wireless antennas, identifying 10
- wireless certification label 18
- wireless, product description 2
- WLAN antennas, identifying 10
- WLAN device 18
- WLAN label 18
- WLAN module
  - illustrated 25
  - removal 50
  - spare part numbers 25, 50
- workstation guidelines 33, 34
- WWAN antennas, identifying 10
- WWAN module
  - illustrated 24
  - removal 47
  - spare part number 24, 47